



**Quick Start Guide / Guide de mise en route**  
**Kurzanleitung / Guida introduttiva**

English / Français / Deutsch / Italiano

CUH-1116A

# Getting started

## 1 Connect to your TV.

Follow the steps 1 to 4 below to connect your PlayStation®4 system to your TV.

Rear view

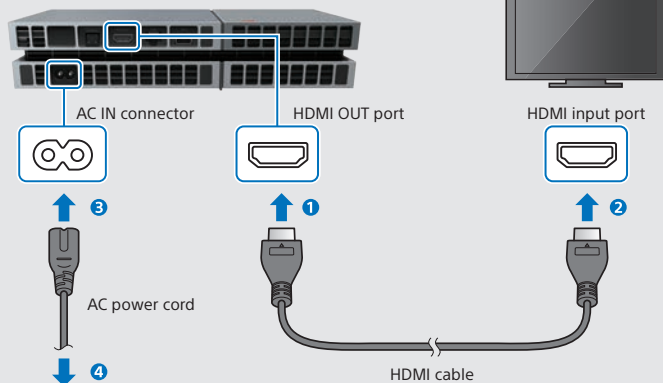

To an electricity supply

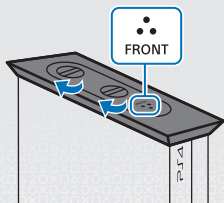

- When using the system in a vertical position, use the supplied vertical stand. Place the PS4™ system on a soft cloth and align the front of the stand with the front of the PS4™ system.
- Do not lift the system only by the stand when the stand is attached.

## 2 Connect the PlayStation®Camera.

Remove the protective film, and then place the camera in front of your TV, at the centre.

Rear view

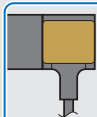
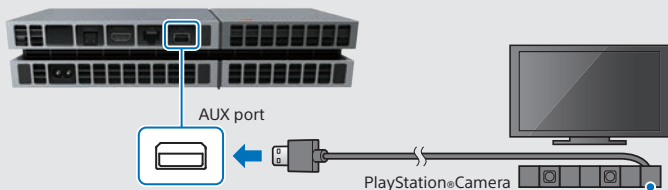

### To fix the camera in place

- 1 Remove the white film from the supplied double-sided tape (for PlayStation®Camera), and then attach the tape to the bottom of the camera.
- 2 Remove the yellow film, and then secure the camera on a horizontal surface in front of your TV.

**NOTE:** The double-sided tape should not be used to attach the camera to the TV itself. Use of the tape to secure the camera to a painted surface may result in the marking or removal of paintwork.

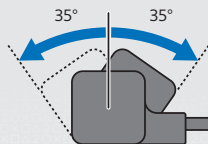

- If the camera's dual lenses ever become dirty, wipe them with a soft cloth.
- If you need to adjust the angle of the camera, rotate it up or down.

### 3 Connect to a LAN cable (sold separately).

No Wi-Fi connection? You can use a LAN cable to connect your PS4™ system to the Internet instead.

To connect your PS4™ system to the Internet via Wi-Fi, do not connect a LAN cable.

Rear view

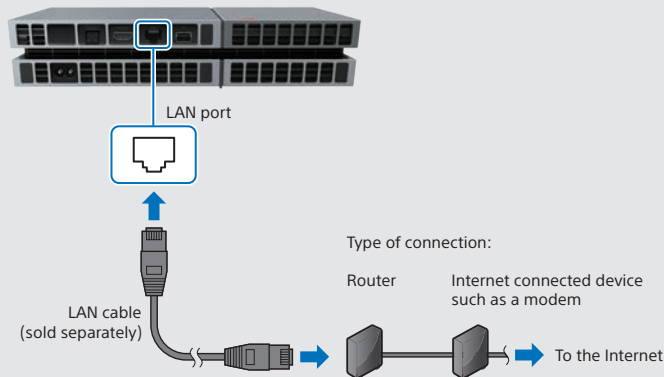

We recommend connecting your PS4™ system to the Internet to get the most out of it.



**4** Turn on your TV, and then change the TV channel to HDMI™.

**5** Turn on your PS4™ system by touching the  (power) button.

The power indicator will blink  blue, before turning  white.



---

If you can't get a picture when the PS4™ system is turned on (the power indicator will turn  white), simply touch the  (power) button for at least 7 seconds (until the system beeps twice) to turn off the power, and then turn on the power again.

---

## 6 Connect your DUALSHOCK®4 wireless controller to your PS4™ system using the USB cable, and then press the (PS) button.

The controller will be registered (paired), and turn on.

## 7 Select your settings.

Set up an Internet connection, set the date and time, and adjust other settings. Follow the on-screen instructions to adjust various settings, and then select [Start Now] from the set-up completion screen.

Once you have set up an Internet connection, a system software update will be downloaded automatically - as will future system software updates.

**Will a child be using your PS4™ system? If so, be sure to read “Setting the parental control” section.**

- 
- You'll need to register the controller in some situations, such as when you use the controller for the first time, or when you use the controller on another PS4™ system.
  - Once you've registered the controller, you can disconnect the USB cable and use the controller wirelessly.
  - You can change any settings that you previously skipped via  (Settings) in the function screen.

# Setting the parental control

Some PS4™ content may not be suitable for your child. Most PS4™ content is rated by an independent ratings body.

To ensure your child only has access to suitably rated content, just set the correct parental control before you first let your child play. You can set the parental controls in  (Settings) in the function screen > [Parental Controls] > [Restrict Use of PS4 Features] > [Application]. Use the tables below for guidance on how the Parental Control Setting relates to different age groups.

You can restrict access to Blu-ray Disc™ and DVD video content, and to the Internet Browser, from  (Settings) in the function screen > [Parental Controls] > [Restrict Use of PS4 Features]. Restricting access to the Internet Browser will not prevent launch of some applications that use the Internet.

Regardless of the Parental Control Settings, you should monitor your child's activity on the PS4™ system. You can override the Parental Control Settings at any time to allow an older child or adult to play.

## Europe, Africa and India

Player's Age	Under 3	3-6	7-11	12-15	16-17	18 and over
PS4™ Parental Control Setting	1	2	3	5	7	9
Highest game age rating						

## Germany

Player's Age	Under 6	6-11	12-15	16-17	18 and over
PS4™ Parental Control Setting	1	3	5	7	9
Highest game age rating					

## Portugal

Player's Age	Under 4	4-5	6-11	12-15	16-17	18 and over
PS4™ Parental Control Setting	1	2	3	5	7	9
Highest game age rating		 www.esrb.org	 www.esrb.org	 www.esrb.org	 www.esrb.org	 www.esrb.org

For more information on parental controls and age ratings please visit [eu.playstation.com/parents](http://eu.playstation.com/parents) or go to the Settings section of the User's Guide.



# Using the screen

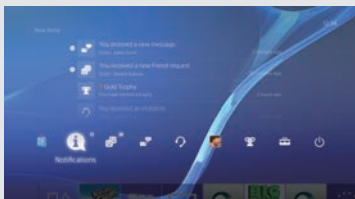

## Function screen

Access several features here including your current Trophy details, new notifications, Friends and Settings. To enjoy some features, you must have an Internet connection or be signed in to PSN<sup>SM</sup>.



Up button/  
Down button



## Home screen

### Content area

Access your games and other content. All content is listed from left to right in order of the most recently accessed.



Up button/  
Down button

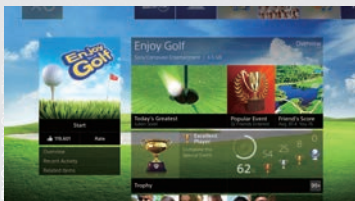

## Content info screen

Access the latest information about the currently selected content. To display the latest information, you must be signed in to PSN<sup>SM</sup>.

# Playing games

## 1 Insert a disc.

The game will appear in the content area of the home screen.

Front view



## 2 Select the game to start playing.



### Quitting a game

Press and hold the  (PS) button, and then select [Close Application].

### Returning to the home screen from a game

To return to the home screen without quitting a game, press the  (PS) button.

To resume playing the game, select it from the content area.

### Removing a disc

Touch the  (eject) button.

Front view



Eject button

## Go to (PlayStation®Store)

Now that you've got a PS4™ system, it's time to head over to see what's available at PlayStation®Store.

PlayStation®Store has a wide variety of downloadable content, some of which you can't get anywhere else. You'll find games to suit every taste, as well as game add-ons that make your games even more fun to play, plus free demos and much, much more. And you can even begin playing your games before they've finished downloading.

To use PlayStation®Store, you must have a Sony Entertainment Network (SEN) account and an Internet connection. PlayStation®Store and SEN subject to terms and country and language restrictions, see [eu.playstation.com/legal](http://eu.playstation.com/legal) for details.

Users are responsible for internet service fees. Users must be 7 years or older and users under 18 require parental consent. Additional age restrictions may apply. Charges apply for some content and/or services.

## Sharing your gaming experience

When using some of the PS4™ system's online services, you can upload screenshots and video clips of gameplay from a game, and broadcast (stream) your gameplay.

To use these features, you must have an SEN master account and an Internet connection.

## Using a mono headset

Connect the mono headset to your controller for in-game voice chat.

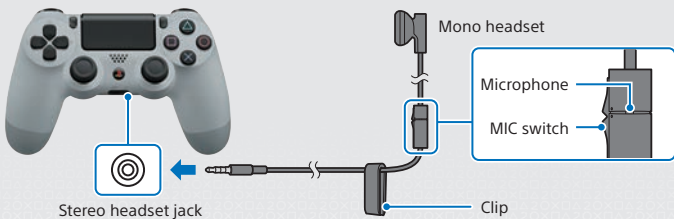

# Creating an SEN account

---

Create an SEN account to use PSN<sup>SM</sup> and SEN services such as PlayStation®Store and Music Unlimited\*.

\* Not available in all countries.

- You can create your own SEN account for free.
- You must have an Internet connection to use services. You must also update the system software to the latest version.
- A maximum of 16 accounts can be registered on each PS4™ system.
- To create a sub account for users under a certain age, you must first create a master account for a parent or guardian.
- Accounts created on a PlayStation®3 system, a PlayStation®Vita system, or a computer can be used on the PS4™ system.

## If you do not have an SEN account

Select  (Settings) > [PSN<sup>SM</sup>] > [Sign In to PSN] from the function screen, and then follow the screens to create an account.



## If you already have an SEN account

Select  (Settings) > [PSN<sup>SM</sup>] > [Sign In to PSN] from the function screen, enter your sign-in ID and password, and then select [Sign In].

# Using the controller

## Charging

To use your controller wirelessly, you must first charge its battery. Press and hold the  (PS) button and the controller's battery charge level will be shown on-screen.

- 1 Turn on your PS4™ system (the power indicator will light up , or set it to standby mode (the power indicator will light up .**
- 2 Connect your controller to your PS4™ system with the USB cable.**

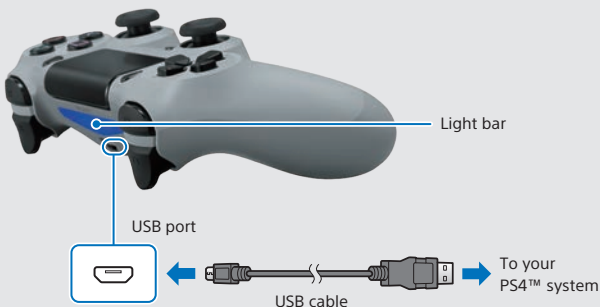

To charge your controller when in standby mode, you must first checkmark the [Supply Power from USB Ports] option in  (Settings) > [Power Saving Settings] > [Set Functions Available in Standby Mode].

---

## Using multiple controllers

You can use up to 4 controllers at the same time.

When you press the  (PS) button on a controller for which registration has been completed, a colour will be assigned to that user and the light bar will light up in their own colour, depending on the order in which they join in. The first user is blue, the second is red, the third is green and the fourth is pink.



# Turning off the power

## Caution

If you disconnect the AC power cord while the power indicator is lit or blinking, data might be lost or corrupted, or the system might become damaged. You must disconnect the AC power cord only once the power is turned off completely. Be sure to read the "Turning off the power completely" section below.

## Entering standby mode

You can charge the controller from a USB port and remain signed in to PSN<sup>SM</sup> while in standby mode.

Select  (Power) from the function screen, and then select [Enter Standby Mode]. The picture will disappear, and the power indicator will blink  white, before turning  orange.



To exit standby mode, press the  (PS) button.

## Turning off the power completely

Select  (Power) from the function screen, and then select [Turn Off PS4].

The picture will disappear, and the power indicator will blink  white, before turning off.



## Power indicator status

 White	The power is on
 Orange	Standby mode
Unlit	The power is off

# Further information

---

## User's Guide



The User's Guide contains more information about what your PS4™ system can do – including how to adjust settings, how long to charge the controller for and how to use each function. Select  (Settings) >  (User's Guide) from the function screen.

You can also view the User's Guide by visiting:  
[eu.playstation.com/help/ps4/manuals/](http://eu.playstation.com/help/ps4/manuals/)

You must have an Internet connection to view the User's Guide.

## Safety Guide

The Safety Guide contains information about how to safely use your PS4™ system, and information about specifications. Be sure to read it before using the system.

"", "PlayStation", "DUALSHOCK", " and " are registered trademarks of Sony Computer Entertainment Inc. "PS4" and "PSN" are trademarks of the same company.

"SONY" and " are registered trademarks of Sony Corporation. "Sony Entertainment Network" is a trademark of the same company.

The terms HDMI and HDMI High-Definition Multimedia Interface, and the HDMI Logo are trademarks or registered trademarks of HDMI Licensing LLC in the United States and other countries.

"Blu-ray Disc™" and "Blu-ray™" are trademarks of the Blu-ray Disc Association.

Design and specifications are subject to change without notice.

Information about system functionality and images published in this document may vary from those for your system, depending on the system software version in use. Also, the illustrations and screen images used in this guide may vary from the actual product.

The information contained in this manual is subject to change without notice.





# Mise en route

## 1 Connectez le système à votre téléviseur.

Suivez les étapes 1 à 4 ci-dessous pour connecter le système PlayStation®4 à votre téléviseur.

Vue arrière

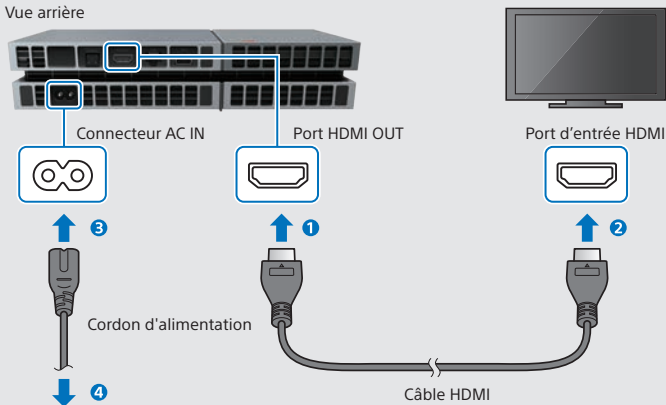

Vers une source d'alimentation électrique

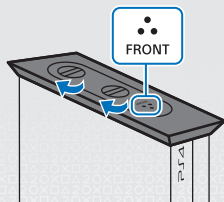

- En cas d'utilisation du système PS4™ en position verticale, utilisez le socle vertical fourni. Posez le système PS4™ sur un chiffon doux et alignez l'avant du socle sur l'avant du système.
- Ne jamais soulever le système par le socle quand le système est posé sur le socle.

## 2 Connectez la PlayStation®Camera.

Retirez le film de protection, puis installez la caméra devant votre téléviseur, au centre.

Vue arrière

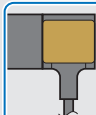
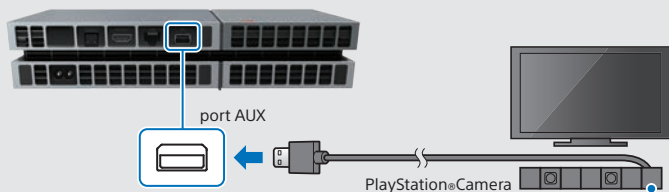

### Pour installer la caméra

- 1 Retirez le film blanc de le ruban adhésif double face fourni (pour PlayStation®Camera), et collez le ruban adhésif sous la partie inférieure de la caméra.
- 2 Retirez le film jaune, puis fixez la caméra sur une surface horizontale devant le téléviseur.

REMARQUE : le ruban adhésif double face ne doit pas être utilisé pour fixer la caméra au téléviseur. L'utilisation de ruban adhésif double face pour fixer la caméra sur une surface peinte peut provoquer un marquage ou un décollement de la peinture.

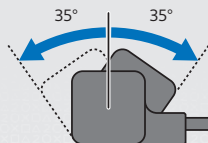

- Si les deux objectifs de la caméra sont sales, nettoyez-les à l'aide d'un chiffon doux.
- Pour ajuster l'angle de la caméra, tournez-la vers le haut ou vers le bas.

### 3 Connectez le câble LAN (vendu séparément).

Pas de connexion Wi-Fi? Vous pouvez utiliser un câble LAN pour connecter votre système PS4™ à Internet.

Pour connecter votre système PS4™ à Internet en Wi-Fi, ne connectez pas de câble LAN.

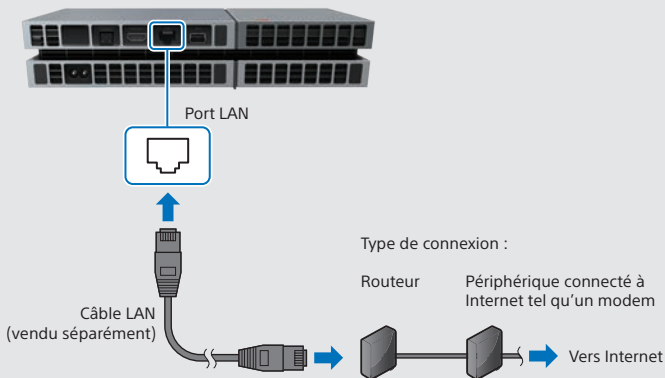

Vue arrière





Nous vous recommandons de connecter votre système PS4™ à Internet pour en profiter au maximum.

**4** Allumez votre téléviseur, puis définissez l'entrée du téléviseur sur HDMI™.

**5** Allumez votre système PS4™ en appuyant sur la touche  (alimentation).

L'indicateur d'alimentation clignote en bleu , puis devient blanc .



Si vous n'obtenez aucune image à la mise en route du système PS4™ (l'indicateur d'alimentation s'allume en blanc ) , appuyez sur la touche  (alimentation) pendant au moins 7 secondes (jusqu'à ce que le système émette deux bips) afin d'éteindre l'alimentation, puis rallumez le système.

---

## **6** Connectez votre manette sans fil DUALSHOCK®4 à votre système PS4™ à l'aide du câble USB, puis appuyez sur la touche (PS).

La manette est enregistrée (associée) et s'allume.

## **7** Sélectionnez vos paramètres.

Établissez une connexion Internet, réglez la date et l'heure, ainsi que les autres paramètres. Suivez les instructions qui s'affichent à l'écran pour régler les différents paramètres, puis sélectionnez [Commencer maintenant] dans l'écran de fin de la configuration.

Une fois la connexion Internet établie, une mise à jour du logiciel du système sera téléchargée automatiquement - tout comme pour les futures mises à jour.

**Un enfant utilisera votre système PS4™? Si oui, consultez la section "Définition du contrôle parental".**

- 
- Vous devrez enregistrer la manette dans certains cas, notamment lorsque vous l'utilisez pour la première fois ou si vous l'utilisez sur un autre système PS4™.
  - Une fois la manette enregistrée, vous pouvez déconnecter le câble USB et utiliser la manette sans fil.
  - Vous pouvez modifier tous les paramètres que vous aviez préalablement sautés via  (Paramètres) dans l'écran de fonctions.

# Définition du contrôle parental

Certains contenus PS4™ peuvent ne pas être adaptés à votre enfant. La majorité des contenus PS4™ est évaluée par un organisme de classification indépendant.

Pour être sûr que votre enfant ait uniquement accès à du contenu adapté, définissez le bon niveau de contrôle parental avant de laisser votre enfant jouer. Vous pouvez définir le contrôle parental à partir de  (Paramètres) dans l'écran de fonctions > [Contrôle parental] > [Restreindre l'utilisation des fonctionnalités PS4] > [Application]. Utilisez les tableaux ci-dessous pour savoir comment définir le paramètre de contrôle parental en fonction des différentes tranches d'âge.





Vous pouvez restreindre l'accès au contenu vidéo des DVD et des Blu-ray Disc™, ainsi qu'au navigateur Internet, à partir de  (Paramètres) dans l'écran de fonctions > [Contrôle parental] > [Restreindre l'utilisation des fonctionnalités PS4]. La restriction de l'accès au navigateur Internet n'empêchera pas le lancement de certaines applications utilisant Internet.

Indépendamment des paramètres de contrôle parental, vous devez surveiller l'activité de votre enfant sur le système PS4™. Vous pouvez retirer les paramètres de contrôle parental à tout moment pour permettre à un adulte ou à un enfant plus âgé de jouer.

## Europe, Afrique et Inde

Âge du joueur	Moins de 3 ans	3-6 ans	7-11 ans	12-15 ans	16-17 ans	18 ans et plus
Paramètre de contrôle parental PS4™	1	2	3	5	7	9
Classification par âge la plus élevée						

## Allemagne

Âge du joueur	Moins de 6 ans	6-11 ans	12-15 ans	16-17 ans	18 ans et plus
Paramètre de contrôle parental PS4™	1	3	5	7	9
Classification par âge la plus élevée					

## Portugal

Âge du joueur	Moins de 4 ans	4-5 ans	6-11 ans	12-15 ans	16-17 ans	18 ans et plus
Paramètre de contrôle parental PS4™	1	2	3	5	7	9
Classification par âge la plus élevée		 www.pegi.info	 www.pegi.info	 www.pegi.info	 www.pegi.info	 www.pegi.info

Pour plus d'informations sur le contrôle parental et la classification d'âge, consultez [eu.playstation.com/parents](http://eu.playstation.com/parents) ou la section Paramètres du Guide de l'utilisateur.



# Utilisation de l'écran

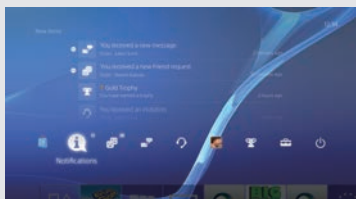

## Écran de fonctions

Cet écran vous permet d'accéder à plusieurs fonctionnalités, et notamment aux détails de votre trophée actuel, aux nouvelles notifications, à vos Amis et aux paramètres. Pour certaines fonctionnalités, vous devez disposer d'une connexion Internet ou être inscrit sur PSN<sup>SM</sup>.



Touche haut/  
Touche bas



## Écran d'accueil

### Zone de contenu

Accéder à vos jeux et à d'autres contenus. Tous les contenus sont répertoriés de gauche à droite, le dernier auquel vous avez accédé apparaissant en premier.



Touche haut/  
Touche bas

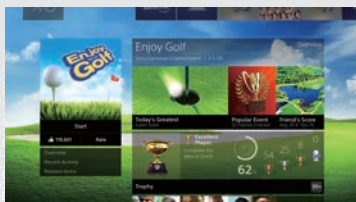

## Écran d'infos du contenu

Accéder aux dernières informations relatives au contenu actuellement sélectionné. Pour afficher les informations les plus récentes, vous devez être inscrit à PSN<sup>SM</sup>.

# Jeux

## 1 Insérez un disque.

Le jeu apparaît dans la zone de contenu de l'écran d'accueil.

Vue avant



## 2 Sélectionnez un jeu pour commencer à jouer.



### Fermeture d'un jeu

Appuyez sur la touche  (PS) et maintenez-la enfoncée, puis sélectionnez [Fermer l'application].

### Retour à l'écran d'accueil à partir d'un jeu

Pour retourner à l'écran d'accueil sans quitter le jeu, appuyez sur la touche  (PS).  
Pour continuer à jouer, sélectionnez le jeu dans la zone de contenu.

### Éjection d'un disque

Appuyez sur la touche  (éjecter).

Vue avant



Toucher d'éjection

## Accès au (PlayStation®Store)

Maintenant que vous possédez un système PS4™, il est temps de voir ce qui est disponible sur le PlayStation®Store.

Le PlayStation®Store possède une large gamme de contenus téléchargeables, dont certains sont exclusifs. Vous trouverez des jeux pour tous les goûts, ainsi que des extensions qui rendront vos jeux encore plus passionnants, des versions d'essai gratuites et bien plus encore. Vous pouvez même commencer à jouer avant la fin du téléchargement de votre jeu.

Pour utiliser le PlayStation®Store, vous devez disposer d'un compte Sony Entertainment Network (SEN) et d'une connexion Internet. Le PlayStation®Store et le SEN sont soumis à des conditions d'utilisation et ne sont pas disponibles dans tous les pays et dans toutes les langues. Pour plus d'informations, consultez [eu.playstation.com/legal](http://eu.playstation.com/legal).

Les frais de connexion à internet sont à la charge des utilisateurs. Les utilisateurs doivent être âgés d'au moins 7 ans et l'accord parental est requis pour les utilisateurs de moins de 18 ans. D'autres restrictions d'âge peuvent s'appliquer. Certains contenus et/ou services peuvent être payants.

## Partage de l'expérience de jeu

Lorsque vous utilisez certains des services en ligne du système PS4™, vous pouvez envoyer des captures d'écran et des clips vidéo d'une partie d'un jeu, et diffuser (en streaming) votre partie.

Pour utiliser ces fonctionnalités, vous devez disposer d'un compte principal SEN et d'une connexion Internet.

## Utilisation d'une oreillette-micro mono

Connectez l'oreillette-micro mono à votre manette pour utiliser le chat vocal pendant le jeu.

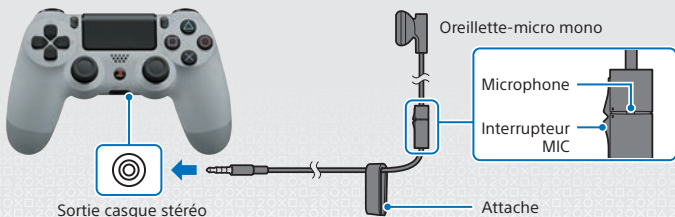

# Création d'un compte SEN

---

Créez un compte SEN pour utiliser les services PSN<sup>SM</sup> et SEN comme le PlayStation®Store et Music Unlimited\*.

\* Ce service n'est pas disponible dans tous les pays.

- Vous pouvez créer votre propre compte SEN gratuitement.
- Vous devez disposer d'une connexion Internet pour utiliser ces services. Vous devez également mettre à jour le logiciel système vers la dernière version.
- 16 comptes au maximum peuvent être enregistrés sur chaque système PS4™.
- Afin de créer un compte secondaire pour des utilisateurs en dessous d'un certain âge, vous devez d'abord créer un compte principal pour un parent ou un tuteur.
- Les comptes créés sur les systèmes PlayStation®3 et PlayStation®Vita ou sur un ordinateur peuvent être utilisés sur le système PS4™.

## Si vous ne possédez pas de compte SEN

Sélectionnez  (Paramètres) > [PSN<sup>SM</sup>] > [Connexion à PSN] dans l'écran de fonctions, puis suivez les instructions affichées pour créer un compte.



## Si vous possédez déjà un compte SEN

Sélectionnez  (Paramètres) > [PSN<sup>SM</sup>] > [Connexion à PSN] dans l'écran de fonctions, entrez votre ID de connexion et votre mot de passe, puis sélectionnez [Connexion].

# Utilisation de la manette

## charge en cours

Pour utiliser votre manette sans fil, vous devez d'abord charger la batterie. Appuyez sur la touche (PS) et maintenez-la enfoncée pour afficher le niveau de charge de la batterie de la manette à l'écran.

- 1 Allumez le système PS4™ (l'indicateur d'alimentation s'allume en blanc ) ou mettez-le en mode veille (l'indicateur d'alimentation s'allume en orange )**.
- 2 Connectez votre manette au système PS4™ à l'aide du câble USB.**

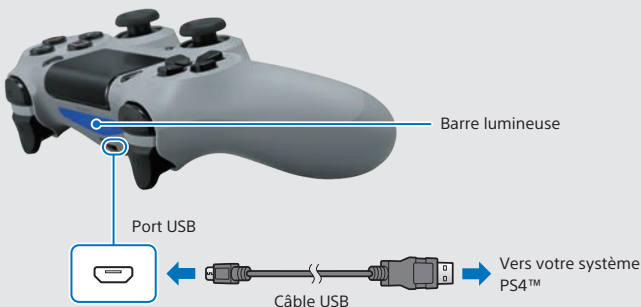

Pour charger votre manette en mode de veille, vous devez tout d'abord cocher l'option [Fournir l'alimentation des ports USB] dans  (Paramètres) > [Paramètres de gestion de l'alimentation] > [Définir les fonctions disponibles en mode veille].

---

## Utilisation de plusieurs manettes

Vous pouvez utiliser jusqu'à 4 manettes en même temps.

En appuyant sur la touche  (PS) d'une manette enregistrée, une couleur sera attribuée à son utilisateur, et la barre lumineuse de la manette prendra cette couleur, en fonction de l'ordre de participation des utilisateurs. Le premier utilisateur apparaît en bleu, le deuxième en rouge, le troisième en vert et le quatrième en rose.



# Mise hors tension du système

## Attention

Si vous déconnectez le cordon d'alimentation alors que l'indicateur d'alimentation est allumé ou clignote, des données pourraient être perdues ou altérées, ou le système pourrait être endommagé. Vous ne devez déconnecter le cordon d'alimentation que lorsque le système est complètement éteint. Consultez la section "Mise hors tension complète" ci-dessous.

## Passage en mode veille

Vous pouvez recharger la manette à partir d'un port USB et rester connecté à PSN<sup>SM</sup> lorsque le système est en mode veille.

Sélectionnez  (Alimentation) dans l'écran de fonctions, puis [Passer en mode veille]. L'image disparaît et l'indicateur d'alimentation clignote en blanc , avant de devenir orange .



Pour quitter le mode veille, appuyez sur la touche  (PS).

## Mise hors tension complète

Sélectionnez  (Alimentation) dans l'écran de fonctions, puis sélectionnez [Éteindre la PS4].



L'image disparaît et l'indicateur d'alimentation clignote en blanc , avant de s'éteindre.

## État de l'indicateur d'alimentation

 Blanc	L'appareil est allumé
 Orange	En mode de veille
Éteint	L'appareil est éteint

# Informations complémentaires

## Guide de l'utilisateur

Le Guide de l'utilisateur contient plus d'informations sur les fonctionnalités de votre système PS4™, notamment sur le réglage des paramètres, le temps de charge de la manette et l'utilisation de chaque fonctionnalité. Sélectionnez  (Paramètres) >  (Guide de l'utilisateur) dans l'écran de fonctions. Vous pouvez également consulter le Guide de l'utilisateur en accédant à : [eu.playstation.com/help/ps4/manuals/](http://eu.playstation.com/help/ps4/manuals/) Vous devez disposer d'une connexion Internet pour consulter le Guide de l'utilisateur.

## Guide de sécurité

Le Guide de sécurité contient des informations sur la façon d'utiliser le système PS4™ en toute sécurité, ainsi que sur les spécifications. Lisez-le attentivement avant d'utiliser le système.

", "PlayStation", "DUALSHOCK", " et "" sont des marques déposées de Sony Computer Entertainment Inc. "PS4" et "PSN" sont des marques commerciales de la même société.

"SONY" et "" sont des marques déposées de Sony Corporation. "Sony Entertainment Network" est une marque commerciale de la même société.

The terms HDMI and HDMI High-Definition Multimedia Interface, and the HDMI Logo are trademarks or registered trademarks of HDMI Licensing LLC in the United States and other countries.

"Blu-ray Disc™" and "Blu-ray™" are trademarks of the Blu-ray Disc Association.

Conception et spécifications sujettes à modification sans préavis.

Les informations relatives aux fonctionnalités du système et les images publiées dans le présent document peuvent être différentes de celles de votre système, selon la version du logiciel du système utilisée. Par ailleurs, les illustrations et reproductions d'écran utilisées dans ce guide peuvent présenter des différences par rapport au produit réel.

Les informations contenues dans ce manuel sont modifiables sans préavis.



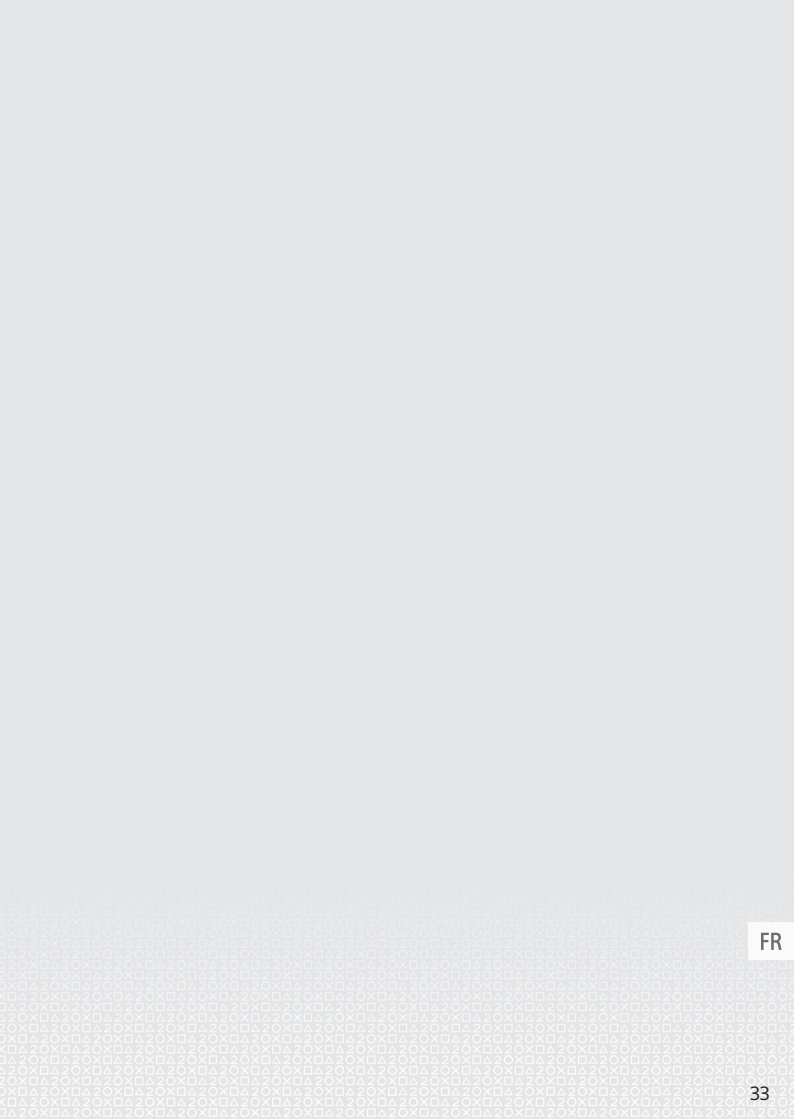

# Erste Schritte

## 1 Schließen Sie das PS4™-System an Ihr Fernsehgerät an.

Befolgen Sie die Schritte 1 bis 4 unten, um das PlayStation®4-System an Ihr Fernsehgerät anzuschließen.

Rückansicht

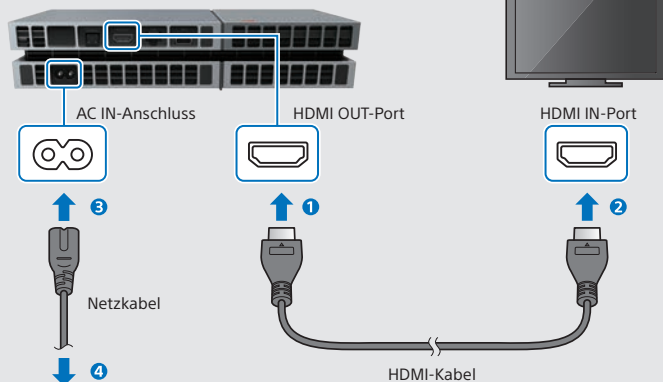

Zur Netzsteckdose

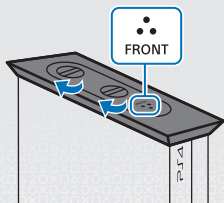

- Wenn das PS4™-System in einer aufrechten Position aufgestellt wird, sollten Sie den vertikalen Standfuß verwenden. Platzieren Sie das PS4™-System auf einem weichen Tuch und richten Sie die Vorderseite des Standfußes an der Vorderseite des Systems aus.
- Heben Sie das System nicht nur am Standfuß, wenn der Standfuß angebracht wurde.

## 2 Schließen Sie die PlayStation®Camera an.

Entfernen Sie die Schutzfolie und platzieren Sie die Kamera dann mittig vor Ihrem Fernseher.

Rückansicht

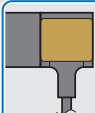
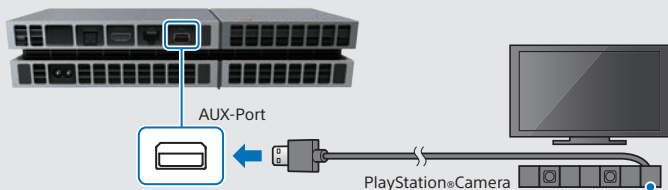

### Fixieren der Kamera

- 1 Entfernen Sie die weiße Folie vom mitgelieferten doppelseitigen Klebeband (für die PlayStation®Camera) und bringen Sie das Klebeband an der Unterseite der Kamera an.
- 2 Entfernen Sie die gelbe Folie und befestigen Sie die Kamera dann auf einer horizontalen Oberfläche vor Ihrem Fernseher.

**HINWEIS:** Das doppelseitige Klebeband sollte nicht dazu verwendet werden, die Kamera am Fernseher selbst anzubringen. Wenn Sie die Kamera mit dem Klebeband an einer verputzten Oberfläche anbringen, ist es möglich, dass Rückstände zurückbleiben oder ein Teil des Putzes entfernt wird.

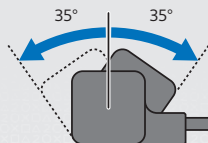

- Wenn die Dual-Objektive der Kamera schmutzig werden, säubern Sie sie mit einem weichen Tuch.
- Wenn Sie den Winkel der Kamera verändern möchten, drehen Sie sie nach oben oder unten.

### 3 Schließen Sie das LAN-Kabel an (separat erhältlich).

Können Sie keine WLAN-Verbindung herstellen? Verwenden Sie stattdessen ein LAN-Kabel, um Ihr PS4™-System mit dem Internet zu verbinden.

Wenn Sie Ihr PS4™-System per WLAN mit dem Internet verbinden möchten, schließen Sie kein LAN-Kabel an.

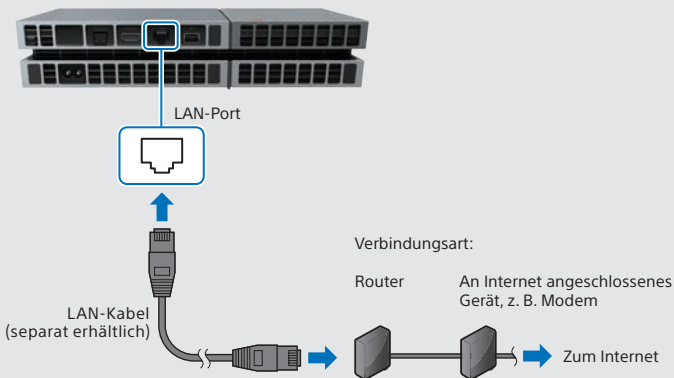

Rückansicht





Wir empfehlen, dass Sie Ihr PS4™-System mit dem Internet verbinden, um alle Funktionen in vollem Umfang nutzen zu können.

- 4** Schalten Sie Ihr Fernsehgerät ein, und wählen Sie als Eingangsquelle den entsprechenden HDMI™-Anschluss aus.

- 5** Schalten Sie das PS4™-System ein, indem Sie die -(Power-)Taste berühren.

Daraufhin blinkt die Power-Kontrollleuchte zunächst blau , bis sie dauerhaft weiß leuchtet .



Wenn bei eingeschaltetem PS4™-System kein Bild angezeigt wird (die Power-Kontrollleuchte leuchtet weiß ) , berühren Sie einfach mindestens sieben Sekunden lang (bis das System zwei Mal piept) die -(Power-)Taste, um das PS4™-System auszuschalten, und schalten Sie es dann wieder ein.

---

## **6 Schließen Sie den DUALSHOCK®4 Wireless-Controller per USB-Kabel an Ihr PS4™-System an, und drücken Sie anschließend auf die -(PS)-Taste.**

Daraufhin wird der Controller registriert (gekoppelt) und eingeschaltet.

## **7 Nehmen Sie die Einstellungen vor.**

Richten Sie eine Internetverbindung ein, stellen Sie das Datum und die Uhrzeit ein, und nehmen Sie weitere Einstellungen vor. Befolgen Sie die Anweisungen auf dem Bildschirm, um die diversen Einstellungen anzupassen, und wählen Sie anschließend auf dem Bildschirm zum Fertigstellen des Einrichtvorgangs die Option [Jetzt starten] aus.

Sobald Sie eine Internetverbindung eingerichtet haben, wird automatisch ein Update für die Systemsoftware heruntergeladen. Auch zukünftige Updates für die Systemsoftware werden automatisch heruntergeladen, wenn das System mit dem Internet verbunden ist.

**Wird ein Kind das PS4™-System nutzen? Wenn ja, lesen Sie den Abschnitt „Einrichten der Kindersicherung“.**

- 
- In einigen Fällen müssen Sie den Controller registrieren, z. B. wenn Sie den Controller zum ersten Mal verwenden oder wenn Sie den Controller an einem anderen PS4™-System verwenden.
  - Sobald Sie den Controller registriert haben, können Sie das USB-Kabel trennen und den Controller kabellos nutzen.
  - Sie können jegliche Einstellungen, die Sie vorher übersprungen haben, jederzeit im Funktionsbildschirm unter  (Einstellungen) ändern.

# Einrichten der Kindersicherung

Einige PS4™-Inhalte sind möglicherweise nicht für Ihr Kind geeignet. Die meisten PS4™-Inhalte werden von einer unabhängigen Stelle hinsichtlich der Altersbeschränkung eingestuft.

Um sicherzustellen, dass Ihr Kind ausschließlich Zugang zu altersgerechten Inhalten hat, richten Sie die Kindersicherung ein, bevor Sie Ihr Kind zum ersten Mal am PS4™-System spielen lassen. Sie können die Kindersicherung unter  (Einstellungen) im Funktionsbildschirm > [Kindersicherung] > [Verwendung von PS4-Funktionen einschränken] > [Anwendung] einstellen. Richten Sie sich nach den Tabellen unten, um die richtige Kindersicherungsstufe für die entsprechende Altersgruppe einzustellen.





Unter  (Einstellungen) im Funktionsbildschirm > [Kindersicherung] > [Verwendung von PS4-Funktionen einschränken] können Sie auch den Zugang zu Blu-ray Disc™- und DVD-Videoinhalten sowie zum Internet-Browser einschränken. Wenn Sie den Zugang zum Internetbrowser einschränken, können einige Anwendungen, die den Internetzugang nutzen, weiterhin gestartet werden.

Sie sollten die Aktivitäten Ihres Kindes am PS4™-System trotz der Kindersicherung weiterhin beobachten. Wenn ein älteres Kind oder ein Erwachsener spielen möchten, können Sie die Kindersicherung jederzeit ändern oder aufheben.

## Europa, Afrika und Indien

Alter der spielenden Person	Unter 3	3-6	7-11	12-15	16-17	18 und älter
PS4™-Kindersicherungsstufe	1	2	3	5	7	9
Höchste Altersbeschränkung						

## Deutschland

Alter der spielenden Person	Unter 6	6-11	12-15	16-17	18 und älter
PS4™- Kindersicherungsstufe	1	3	5	7	9
Höchste Altersbeschränkung					

## Portugal

Alter der spielenden Person	Unter 4	4-5	6-11	12-15	16-17	18 und älter
PS4™- Kindersicherungsstufe	1	2	3	5	7	9
Höchste Altersbeschränkung		 <small>www.pegi.info</small>	 <small>www.pegi.info</small>	 <small>www.pegi.info</small>	 <small>www.pegi.info</small>	 <small>www.pegi.info</small>

Weitere Informationen zur Kindersicherung und zu Altersbeschränkungen finden Sie unter „[eu.playstation.com/parents](http://eu.playstation.com/parents)“ oder im Abschnitt „Einstellungen“ im Benutzerhandbuch.



# Verwenden des Bildschirms

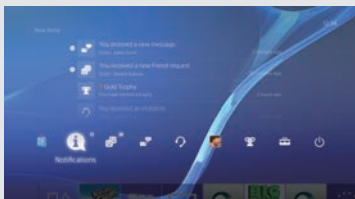

Oben-Taste/  
Unten-Taste

## Funktionsbildschirm

Auf diesem Bildschirm haben Sie Zugang zu diversen Funktionen, wie zu Informationen über gewonnene Trophäen, zu neuen Mitteilungen, zu Freunden und zu Einstellungen.

Für einige der Funktionen muss eine Internetverbindung bestehen, oder Sie müssen bei PSN<sup>SM</sup> angemeldet sein.



## Home-Bildschirm

### Inhaltsbereich

In diesem Bereich können Sie auf Ihre Spiele und weitere Inhalte zugreifen. Alle Inhalte werden absteigend, beginnend beim zuletzt aufgerufenen Inhalt, von links nach rechts angezeigt.



Oben-Taste/  
Unten-Taste

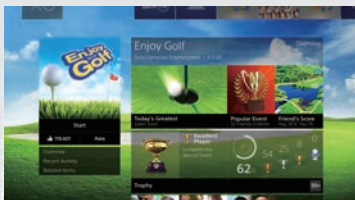

## Inhaltsinfobildschirm

Auf diesem Bildschirm können Sie auf die neuesten Informationen zu dem aktuell ausgewählten Inhalt zugreifen. Sie müssen bei PSN<sup>SM</sup> angemeldet sein, um die neuesten Informationen anzeigen zu können.

# Spiele

## 1 Legen Sie eine Disc ein.

Daraufhin wird das Spiel im Inhaltsbereich auf dem Home-Bildschirm angezeigt.

Vorderansicht



## 2 Wählen Sie das Spiel aus, um mit dem Spielen zu beginnen.



### Beenden eines Spiels

Drücken und halten Sie die **(PS-)** Taste, und wählen Sie anschließend die Option [Anwendung schließen] aus.

### Zurückkehren zum Home-Bildschirm von einem Spiel aus

Wenn Sie zum Home-Bildschirm wechseln möchten, ohne das Spiel zu verlassen, drücken Sie die **(PS-)**Taste. Wenn Sie das Spiel fortsetzen möchten, wählen Sie es im Inhaltsbereich aus.

### Herausnehmen einer Disc

Berühren Sie die **(Auswurf-)** Taste.

Vorderansicht



Auswurf-Taste

## (PlayStation®Store)

Jetzt da Sie ein PS4™-System haben, ist es an der Zeit, PlayStation®Store zu entdecken.

PlayStation®Store bietet eine Vielzahl von Inhalten zum Herunterladen an, wobei es einige einzigartige Inhalte nur dort gibt. Hier finden Sie Spiele für jeden Geschmack, Add-Ons, mit denen das Spielen noch mehr Spaß macht, kostenlose Demoversionen und vieles, vieles mehr. Zudem können Sie Ihre Spiele spielen, noch bevor der Download abgeschlossen wurde.

Um PlayStation®Store nutzen zu können, müssen Sie über ein Sony Entertainment Network-Konto (SEN) und eine Internetverbindung verfügen. Für PlayStation®Store und SEN gelten die jeweiligen Nutzungsbedingungen und sie stehen nur in bestimmten Regionen und Sprachen zur Verfügung. Weitere Informationen finden Sie unter „eu.playstation.com/legal“.

Alle Internet-Service-Gebühren gehen zu Lasten des Benutzers. Die Benutzer müssen mindestens 7 Jahre alt sein, wobei für Benutzer unter 18 Jahren die Zustimmung der Erziehungsberechtigten erforderlich ist. Möglicherweise gelten zusätzliche Altersbeschränkungen. Für einige Inhalte und/oder Services fallen Gebühren an.

### Teilen des Spielerlebnisses

Wenn Sie einige der Online-Services für das PS4™-System nutzen, können Sie Screenshots und Videoclips aus einem Spiel heraus hochladen und veröffentlichen (streamen).

Um diese Funktionen nutzen zu können, benötigen Sie ein SEN-Hauptkonto und eine Internetverbindung.

### Verwenden eines Mono-Headset

Schließen Sie das Mono-Headset an Ihren Controller an, um die Voice-Chat-Funktion von Spielen nutzen zu können.

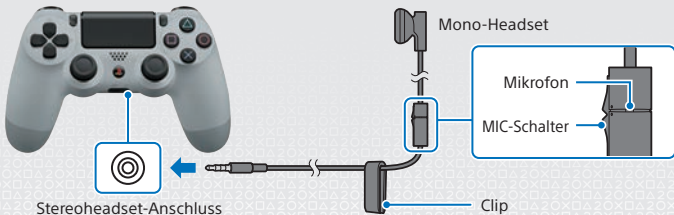

# Erstellen eines SEN-Kontos

---

Erstellen Sie ein SEN-Konto, um PSN<sup>SM</sup>- und SEN-Services wie PlayStation®Store und Music Unlimited\* nutzen zu können.

\* Nicht in allen Ländern verfügbar.

- Sie können kostenlos Ihr eigenes SEN-Konto erstellen.
- Für die Nutzung der Services benötigen Sie eine Internetverbindung. Des Weiteren muss die Systemsoftware auf dem aktuellen Stand sein.
- Für jedes PS4™-System können maximal 16 Konten registriert werden.
- Um ein Unterkonto für Benutzer zu erstellen, die ein bestimmtes Alter noch nicht erreicht haben, muss zunächst ein Hauptkonto für die Eltern oder die Erziehungsberechtigten erstellt werden.
- Konten, die auf einem PlayStation®3-System, einem PlayStation®Vita-System oder einem Computer erstellt wurden, können auch auf dem PS4™-System verwendet werden.

## Wenn Sie noch nicht über ein SEN-Konto verfügen

Wählen Sie im Funktionsbildschirm die Option  (Einstellungen) > [PSN<sup>SM</sup>] > [Beim PSN anmelden] aus, und folgen Sie den Anweisungen auf dem Bildschirm zum Erstellen eines Kontos.



## Wenn Sie bereits über ein SEN-Konto verfügen

Wählen Sie im Funktionsbildschirm die Option  (Einstellungen) > [PSN<sup>SM</sup>] > [Beim PSN anmelden] aus, geben Sie Ihre Anmelde-ID und das Passwort ein, und wählen Sie dann die Option [Anmelden] aus.

# Verwenden des Controllers

## Laden

Damit Sie Ihren Controller kabellos nutzen können, müssen Sie zunächst den Akku aufladen. Wenn Sie die **(PS-)**Taste drücken und halten, wird der Ladezustand des Akkus auf dem Bildschirm angezeigt.

- 1** Schalten Sie Ihr PS4™-System ein (die Power-Kontrollleuchte leuchtet weiß ) , oder versetzen Sie das System in den Bereitschaftsmodus (die Power-Kontrollleuchte leuchtet orange ).
- 2** Schließen Sie den Controller per USB-Kabel an Ihr PS4™-System an.

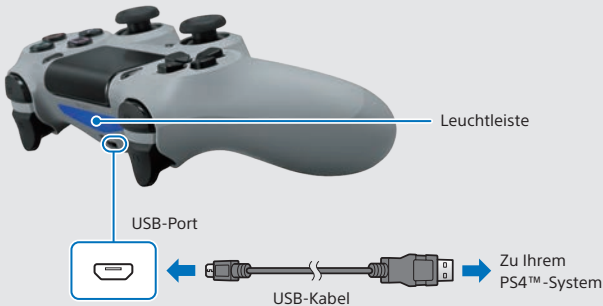

Um den Controller im Bereitschaftsmodus laden zu können, müssen Sie zunächst unter  (Einstellungen) > [Energiespar-Einstellungen] > [Im Bereitschaftsmodus verfügbare Funktionen einstellen] die Option [Stromversorgung über USB-Ports] aktivieren.

---

## Verwenden mehrerer Controller

Es können bis zu 4 Controller gleichzeitig verwendet werden. Wird auf einem Controller, für den die Anmeldung abgeschlossen wurde, die -(PS-)Taste gedrückt, wird diesem Benutzer eine Farbe zugewiesen. Die Farbe der Leuchteiste hängt von der Reihenfolge ab, in der sich die Benutzer anmelden. Der erste Benutzer ist blau, der zweite rot, der dritte grün und der vierte pink.



# Ausschalten

## **Vorsicht**

Wenn Sie das Netzkabel bei leuchtender oder blinkender Power-Kontrollleuchte aus der Netzsteckdose ziehen, gehen möglicherweise Daten verloren oder die Daten bzw. das System werden möglicherweise beschädigt. Ziehen Sie das Netzkabel nur bei vollständig ausgeschaltetem System aus der Netzsteckdose. Lesen Sie den Abschnitt „Vollständiges Ausschalten“ weiter unten.

## In Bereitschaftsmodus versetzen

Im Bereitschaftsmodus können Sie den Controller am USB-Port laden und bei PSN<sup>SM</sup> angemeldet bleiben.

Wählen Sie im Funktionsbildschirm das Symbol  (Power) aus, und wählen Sie anschließend die Option [In Bereitschaftsmodus wechseln] aus. Daraufhin wird kein Bild mehr angezeigt, und die Power-Kontrollleuchte blinkt zunächst weiß , bis sie dauerhaft orange leuchtet .



Um den Bereitschaftsmodus zu verlassen, drücken Sie die -(PS-)Taste.

## Vollständiges Ausschalten

Wählen Sie im Funktionsbildschirm das Symbol  (Power) aus, und wählen Sie anschließend die Option [PS4 ausschalten] aus.

Daraufhin wird kein Bild mehr angezeigt, und die Power-Kontrollleuchte blinkt zunächst weiß , bis sie aus geht.



## Zustand Power-Kontrollleuchte

 Weiß	Das System ist eingeschaltet.
 Orange	Das System ist im Bereitschaftsmodus.
Aus	Das System ist ausgeschaltet.

# Weitere Informationen

---

## Benutzerhandbuch

Das Benutzerhandbuch enthält detaillierte Informationen zu den Funktionen Ihres PS4™-Systems. Dazu zählen u. a. Informationen zum Anpassen der Einstellungen, zur Ladezeit des Controllers sowie Informationen zur Verwendung der einzelnen Funktionen. Wählen Sie im Funktionsbildschirm die Option  (Einstellungen) >  (Benutzerhandbuch) aus, um das Benutzerhandbuch aufzurufen.

Zusätzlich finden Sie das Benutzerhandbuch unter folgendem Link:

[eu.playstation.com/help/ps4/manuals/](http://eu.playstation.com/help/ps4/manuals/)

Für das Anzeigen des Benutzerhandbuchs ist eine Internetverbindung erforderlich.

## Sicherheitsanleitung

Die Sicherheitsanleitung enthält Informationen zur sicheren Verwendung Ihres PS4™-Systems sowie Informationen zu technischen Daten. Lesen Sie die Sicherheitsanleitung aufmerksam durch, bevor Sie das System verwenden.

„PS“, „PlayStation“, „DUALSHOCK“, „△○×□“ und „PS“ sind registrierte Marken von Sony Computer Entertainment Inc. „PS4“ und „PSN“ sind Marken desselben Unternehmens.

„SONY“ und  sind registrierte Marken von Sony Corporation. „Sony Entertainment Network“ ist eine Marke desselben Unternehmens.

The terms HDMI and HDMI High-Definition Multimedia Interface, and the HDMI Logo are trademarks or registered trademarks of HDMI Licensing LLC in the United States and other countries.

„Blu-ray Disc™“ and „Blu-ray™“ are trademarks of the Blu-ray Disc Association.

Das Design und die technischen Daten können ohne Vorankündigung geändert werden.

Die in diesem Dokument enthaltenen Informationen über Systemfunktionen sowie die veröffentlichten Bilder weichen je nach verwendeter Systemsoftwareversion möglicherweise von Ihrem System ab. Des Weiteren entsprechen möglicherweise die Illustrationen und Screenshots in dieser Anleitung nicht voll und ganz dem tatsächlichen Produkt.

Die in dieser Bedienungsanleitung enthaltenen Informationen können ohne vorherige Ankündigung geändert werden.



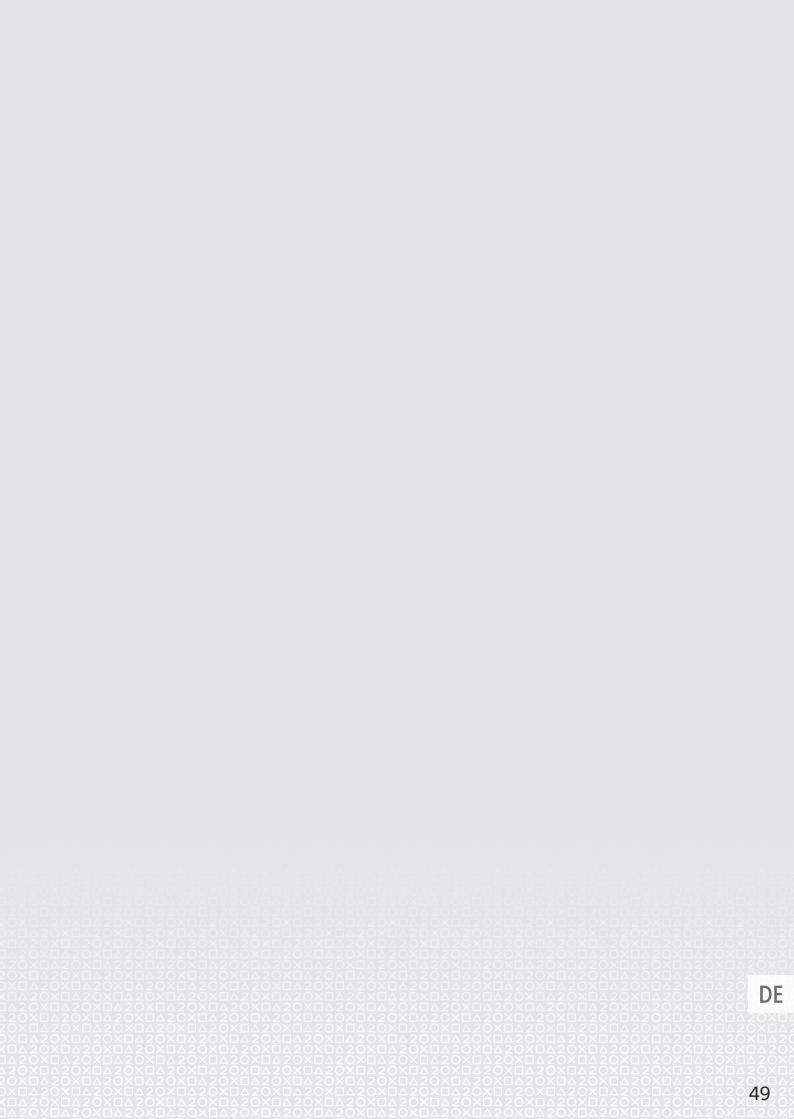

# Attività iniziali

## 1 Collegamento al televisore.

Attenersi ai passaggi da 1 a 4 che seguono per collegare il sistema PlayStation®4 al televisore.

Vista posteriore

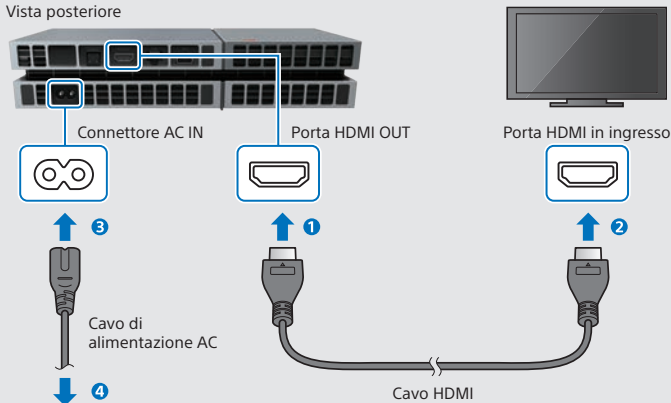

Alla presa elettrica

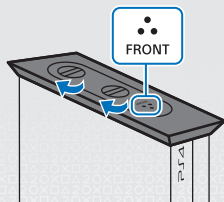

- Quando il sistema PS4™ è in posizione verticale, utilizzare la base verticale fornita in dotazione. Posizionare sistema PS4™ su un panno morbido e allineare la parte anteriore della base con la parte anteriore del sistema.
- Quando la base è fissata, non sollevare il sistema impugnandolo soltanto dalla base.

## 2 Connettere la PlayStation®Camera.

Rimuovere la pellicola protettiva e posizionare la telecamera in posizione centrale di fronte al TV.

Vista posteriore

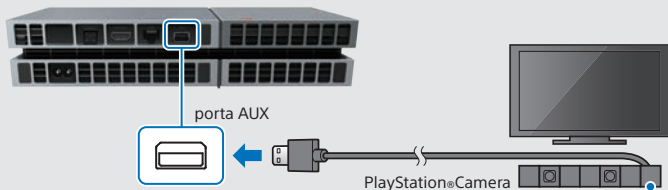

### Per fissare la telecamera

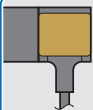

- 1 Rimuovere la pellicola bianca dal nastro biadesivo fornito in dotazione (per PlayStation®Camera) e fissare il nastro alla parte inferiore della telecamera.
- 2 Rimuovere la pellicola gialla e fissare la telecamera su una superficie orizzontale di fronte al TV.

NOTA: Il nastro biadesivo non può essere utilizzato per fissare la telecamera direttamente al televisore. L'uso del nastro per fissare la telecamera a una superficie pitturata potrebbe comportare il danneggiamento o il distacco della vernice.

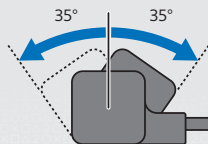

- Se le doppie lenti della telecamera sono sporche, procedere alla pulizia con un panno morbido.
- Per regolare l'angolazione della telecamera, ruotarla verso l'alto o il basso.

### 3 Collegamento al cavo LAN (venduto separatamente).

Se non si dispone di una connessione Wi-Fi, è possibile utilizzare un cavo LAN per collegare il sistema PS4™ a Internet.

Per collegare il sistema PS4™ a Internet tramite Wi-Fi, non collegare alcun cavo LAN.

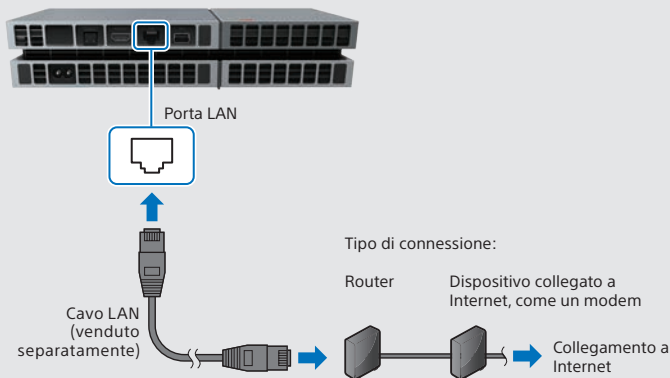

Vista posteriore





Si consiglia di collegare il sistema PS4™ a Internet per poterlo sfruttare al massimo.

**4** Accendere il televisore e cambiare il canale impostandolo sull'ingresso HDMI™.

**5** Accendere il sistema PS4™ toccando il tasto  (accensione).

L'indicatore di accensione lampeggerà con il colore blu , prima di diventare di colore bianco .



Se non si riesce a scattare una foto quando il sistema PS4™ è acceso (indicatore di accensione bianco ) , toccare il tasto  (accensione) per almeno 7 secondi (finché il sistema non emette un doppio segnale acustico) per spegnerlo, quindi riaccenderlo.

---

## **6** Connettere il controller wireless DUALSHOCK®4 al sistema PS4™ utilizzando il cavo USB, quindi premere il tasto (PS).

Il controller verrà registrato (accoppiato) e acceso.

## **7** Selezionare le impostazioni desiderate.

Impostare una connessione Internet, impostare la data e l'ora e configurare le altre impostazioni. Attenersi alle istruzioni su schermo per regolare le varie impostazioni, quindi selezionare [Avvia ora] dalla schermata di completamento della configurazione.

Dopo aver configurato una connessione Internet, un aggiornamento del software verrà scaricato automaticamente, così come avverrà in futuro per gli altri aggiornamenti del software.

**Se un bambino utilizzerà il sistema PS4™, leggere attentamente la sezione "Impostazione della funzione controllo genitori".**

- 
- Sarà necessario registrare il controller in determinate situazioni, come quando si utilizza il controller per la prima volta o quando si utilizza il controller di un altro sistema PS4™.
  - Una volta registrato il controller, è possibile scollegare il cavo USB e utilizzare il controller in modalità wireless.
  - È possibile modificare qualsiasi impostazione precedentemente saltata utilizzando  (Impostazioni) nella schermata delle funzioni.

# Impostazione della funzione controllo genitori

Alcuni contenuti per PS4™ potrebbero essere non adatti ai bambini. La maggior parte dei contenuti per PS4™ è classificata da un organismo indipendente.

Per assicurarsi che i bambini abbiano accesso soltanto a contenuti adatti a loro, è sufficiente regolare il controllo genitori prima di consentire ai bambini di giocare. È possibile impostare il controllo genitori in  (Impostazioni) all'interno della schermata delle funzioni > [Filtro contenuti] > [Limita l'uso delle funzioni della PS4] > [Applicazione]. Utilizzare le tabelle che seguono come guida sulla modalità di configurazione delle impostazioni di controllo genitori in base ai diversi gruppi di età.

È possibile limitare l'accesso ai contenuti video su Blu-ray Disc™ e DVD e l'accesso al browser per Internet da  (Impostazioni) nella schermata delle funzioni > [Filtro contenuti] > [Limita l'uso delle funzioni della PS4]. Limitando l'accesso al browser per Internet non viene bloccato l'uso delle applicazioni che utilizzano Internet.

Indipendentemente dalle impostazioni del controllo genitori, i genitori dovrebbero sempre monitorare le attività che i bambini svolgono sul sistema PS4™. È possibile disattivare le impostazioni del controllo genitori in qualsiasi momento per consentire di giocare a un ragazzo più grande o a un adulto.

## Europa, Africa e India

Età del giocatore	Meno di 3 anni	3-6 anni	7-11 anni	12-15 anni	16-17 anni	18 anni o più
Impostazione del controllo genitori per PS4™	1	2	3	5	7	9
Classificazione per età						

## Germania

Età del giocatore	Meno di 6 anni	6-11 anni	12-15 anni	16-17 anni	18 anni o più
Impostazione del controllo genitori per PS4™	1	3	5	7	9
Classificazione per età					

## Portogallo

Età del giocatore	Meno di 4 anni	4-5 anni	6-11 anni	12-15 anni	16-17 anni	18 anni o più
Impostazione del controllo genitori per PS4™	1	2	3	5	7	9
Classificazione per età		 www.pegi.info	 www.pegi.info	 www.pegi.info	 www.pegi.info	 www.pegi.info

Per ulteriori informazioni sul controllo genitori e sulla classificazione per età, visitare [eu.playstation.com/parents](http://eu.playstation.com/parents) o andare alla sezione Impostazioni della Guida per l'utente.



# Uso dello schermo

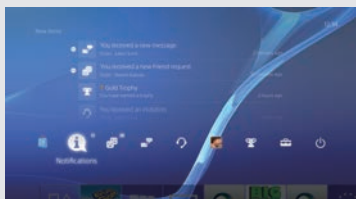

## Schermata funzioni

In questa schermata è possibile accedere a diverse funzioni tra cui i dettagli dei trofei vinti, nuove notifiche, Amici e impostazioni.

Per poter utilizzare determinate funzioni, è necessario disporre di una connessione Internet o aver effettuato l'accesso a PSN<sup>SM</sup>.



Tasto su/  
Tasto giù



## Schermata principale

### Area contenuti

Accesso a giochi e altri contenuti. Tutti i contenuti sono elencati da sinistra a destra, dal più recente al meno recente.



Tasto su/  
Tasto giù

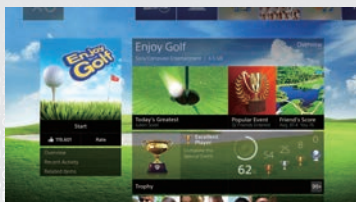

## Schermata info contenuti

Accesso alle ultime informazioni sui contenuti attualmente selezionati. Per visualizzare le più recenti informazioni, è necessario aver effettuato l'accesso a PSN<sup>SM</sup>.

# Gioco

## 1 Inserire un disco.

Il gioco verrà visualizzato nell'area contenuti della schermata principale.

Vista frontale



## 2 Selezionare il gioco che si desidera avviare.



### Chiusura di un gioco

Premere e tenere premuto il tasto  (PS), quindi selezionare [Chiudi applicazione].

### Ritorno alla schermata principale da un gioco

Per tornare alla schermata principale senza chiudere un gioco, premere il tasto  (PS).  
Per riprendere il gioco, selezionarlo dall'area contenuti.

### Rimozione di un disco

Toccare il tasto  (espulsione).

Vista frontale



Tasto di espulsione

## Visitare (PlayStation®Store)

Ora che si dispone di un sistema PS4™, è il momento di scoprire i contenuti disponibili nel PlayStation®Store.

PlayStation®Store offre una vasta gamma di contenuti scaricabili, alcuni dei quali sono introvabili altrove. Sono disponibili giochi per ogni gusto, add-on per i giochi per sfruttare al massimo i giochi che si preferiscono, demo gratuite e molto altro ancora. È anche possibile iniziare a giocare prima del completamento del download.

Per utilizzare PlayStation®Store, è necessario disporre di un account Sony Entertainment Network (SEN) e di una connessione Internet. PlayStation®Store e SEN sono soggetti a specifiche condizioni per l'uso e non sono disponibili in tutti i paesi e in tutte le lingue; per ulteriori dettagli, visitare [eu.playstation.com/legal](http://eu.playstation.com/legal).

Gli utenti sono responsabili del pagamento delle tariffe della connessione Internet. Gli utenti devono avere almeno 7 anni; per l'uso da parte dei minori di 18 anni è richiesto il consenso dei genitori. Possono essere applicate ulteriori restrizioni di età. Alcuni servizi e/o contenuti possono essere a pagamento.

## Condivisione dell'esperienza di gioco

Quando si utilizzano alcuni servizi online del sistema PS4™, è possibile caricare istantanee e video della partita e trasmetterli.

Per utilizzare queste funzioni, è necessario disporre di un account SEN master e di una connessione Internet.

## Uso di un auricolare mono

Collegare gli auricolare mono al controller per utilizzare la chat vocale durante il gioco.

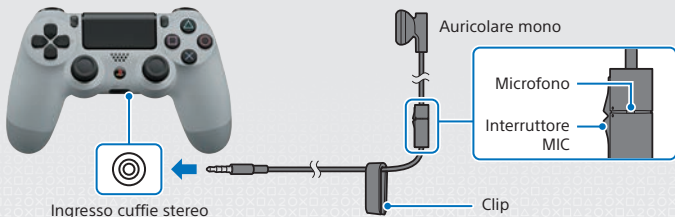

# Creazione di un account SEN

---

Creare un account SEN per utilizzare i servizi PSN<sup>SM</sup> e SEN come PlayStation®Store e Music Unlimited\*.

\* Non disponibile in tutti i paesi.

- È possibile creare il proprio account SEN gratuitamente.
- È necessario disporre di una connessione Internet per utilizzare i servizi. È anche necessario aggiornare il software di sistema con l'ultima versione.
- Per ogni sistema PS4™ è possibile registrare un massimo di 16 account.
- Per creare un sub-account per utenti di una determinata età, è necessario innanzi tutto creare un account master per un genitore o tutore.
- Gli account creati su un sistema PlayStation®3, PlayStation®Vita o su un computer possono essere utilizzati sul sistema PS4™.

## Se non si dispone di un account SEN

Selezionare  (Impostazioni) > [PSN<sup>SM</sup>] > [Accedi a PSN] dalla schermata delle funzioni, quindi creare un account.



## Se si dispone di un account SEN

Selezionare  (Impostazioni) > [PSN<sup>SM</sup>] > [Accedi a PSN] dalla schermata delle funzioni, immettere i propri ID e password per l'accesso, quindi selezionare [Accedi].

# Uso del controller

## Caricamento

Per utilizzare il controller in modalità wireless, è necessario innanzi tutto caricare la sua batteria. Premere e tenere premuto il tasto (PS), il livello di carica della batteria del controller verrà visualizzato su schermo.

- 1 Accendere il sistema PS4™ (l'indicatore di accensione si accenderà con il colore bianco ) ,oppure impostarlo in modalità standby (l'indicatore di accensione si accenderà con il colore arancione ).**
- 2 Collegare il controller al sistema PS4™ con il cavo USB.**

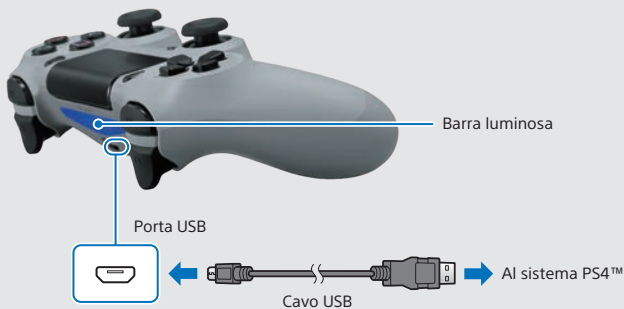

Per caricare il controller mentre si trova in modalità standby, è necessario prima selezionare l'opzione [Alimentazione tramite porte USB] in  (Impostazioni) > [Impostazioni di risparmio energetico] > [Imposta le funzioni disponibili nella modalità standby].

---

## Uso di più controller

È possibile utilizzare fino a 4 controller contemporaneamente.

Quando premi il tasto  (PS) da un controller per cui è stata completata la registrazione, viene assegnato un colore all'utente e la barra luminosa si illumina con il colore corrispondente, a seconda dell'ordine in cui gli utenti si sono collegati. Al primo utente è assegnato il colore blu, al secondo il rosso, al terzo il verde e al quarto il rosa.



# Spegnimento

## **Attenzione**

Se si scollega il cavo di alimentazione AC mentre l'indicatore di accensione e acceso o lampeggiante, potrebbe verificarsi una perdita o un danneggiamento dei dati oppure il sistema potrebbe risultarne danneggiato. Scollegare il cavo di alimentazione AC soltanto dopo aver spento completamente il sistema. Leggere attentamente la sezione "Spegnimento completo" di cui sotto.

## Attivazione della modalità standby

È possibile caricare il controller tramite la porta USB e rimanere collegati a PSN<sup>SM</sup> durante la modalità standby.

Selezionare  (Spegnimento) dalla schermata delle funzioni, quindi selezionare [Entra in modalità standby]. L'immagine scomparirà e l'indicatore di accensione lampeggerà con il colore bianco  prima di diventare arancione .



Per uscire dalla modalità standby, premere il tasto  (PS).

## Spegnimento completo

Selezionare  (Spegnimento) dalla schermata delle funzioni, quindi selezionare [Spegni la PS4].



L'immagine scomparirà e l'indicatore di accensione lampeggerà con il colore bianco  prima di spegnersi.

## Stato indicatore di accensione

 Bianco	Acceso
 Arancione	Modalità standby
Spento	Spento

# Ulteriori informazioni

## Guida per l'utente



La Guida per l'utente contiene maggiori informazioni sul sistema PS4™, incluse le modalità per regolare le impostazioni, informazioni sulla durata di carica del controller e le modalità di utilizzo di ciascuna funzione. Selezionare  (Impostazioni) >  (Guida per l'utente) dalla schermata delle funzioni.

È anche possibile consultare la Guida per l'utente visitando:  
[eu.playstation.com/help/ps4/manuals/](http://eu.playstation.com/help/ps4/manuals/)

Per visualizzare la Guida per l'utente è necessario disporre di una connessione Internet.

## Guida alla sicurezza

La Guida alla sicurezza contiene informazioni sull'uso sicuro del sistema PS4™ e informazioni sulle caratteristiche tecniche. Leggere attentamente tale guida prima di utilizzare il sistema.

", "PlayStation", "DUALSHOCK", " e "

" sono marchi registrati di Sony Computer Entertainment Inc. "PS4" e "PSN" sono marchi commerciali della stessa società.

"SONY" e "

" sono marchi registrati di Sony Corporation. "Sony Entertainment Network" è un marchio commerciale della stessa società.

The terms HDMI and HDMI High-Definition Multimedia Interface, and the HDMI Logo are trademarks or registered trademarks of HDMI Licensing LLC in the United States and other countries.

"Blu-ray Disc™" and "Blu-ray™" are trademarks of the Blu-ray Disc Association.

Il design e le caratteristiche tecniche sono soggetti a modifiche senza preavviso.

Le informazioni sulle funzionalità del sistema e le immagini pubblicate nel presente documento potrebbero essere diverse da quelle del sistema, a seconda della versione del software di sistema utilizzata. Le illustrazioni e le immagini dello schermo utilizzate in questa guida possono essere diverse rispetto al reale prodotto.

Le informazioni contenute nel presente manuale sono suscettibili di modifiche senza preavviso.

SONY



COMPUTER  
ENTERTAINMENT®



4 - 559 - 982 - 11(1)

4-559-982-11(1)

© 2014 Sony Computer Entertainment Inc. Printed in China

SONY®