

SONY®



PlayStation®Portable

**Quick Reference**

PSP-3004

4-115-362-41(1) GB

# Using "XMB" (XrossMediaBar)



## GAME

Playing games



## VIDEO

Playing video



## MUSIC

Playing music



## PHOTO

Displaying images



## NETWORK

Connecting to the Internet



## SETTINGS

Adjusting PSP® system settings

The PSP® system includes a user interface called "XMB" (XrossMediaBar). The main screen for "XMB" is called the "home menu".



- 1 Select a category using the left or right button.
- 2 Select an item using the up or down button.
- 3 Press the  $\otimes$  button to confirm the selected item.

Icons displayed in the home menu vary depending on the system software version.

This document describes basic operations of the PSP® system. For detailed instructions, refer to the online user's guide (▶▶page 25).

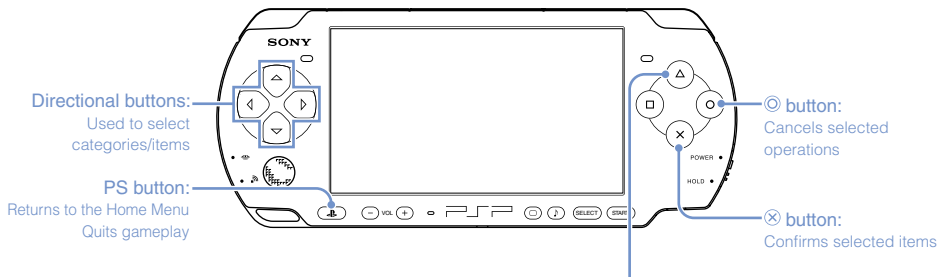

⊙ button: Displays the options menu/control panel

Select an icon, and then press the ⊙ button to display the options menu.



Icons

Options menu

While playing content, press the ⊙ button to display the control panel.



Control panel

# 01 Preparation

## Checking the package contents

Check that you have all of the following items.

If any items are missing, contact the appropriate PSP® customer service helpline which can be found within every PSP® format software manual.

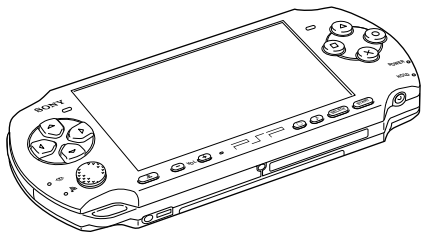

PSP® (PlayStation®Portable) system

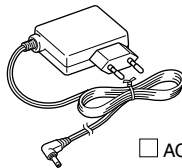

AC Adaptor



Battery Pack

Printed Materials

#### About the PSP® system documentation

The PSP® system documentation includes the following:

- **Safety and Support**

Before using the product, carefully read this document first. It contains safety information related to the use of the PSP® system, troubleshooting, specifications and other information.

- **Quick Reference (this document)**

This document contains information on basic hardware operations of the PSP® system.

- **User's Guide**

(access from : [eu.playstation.com/manuals](http://eu.playstation.com/manuals))

This online document is accessed through the Internet and contains detailed information related to the use of the PSP® system software (▶▶ page 25).

## Preparing the PSP® system for use

**Charging the battery**

Before using the PSP® system for the first time after purchase, you must follow these steps to charge the battery.

**⚠ Caution**

- The socket-outlet shall be installed near the equipment and shall be easily accessible.
- Do not plug the AC Adaptor for the PSP® system into an electrical outlet until you have made all other connections.

**1 Remove the battery cover.**

While holding down the release button, slide the battery cover in the direction of the arrow.

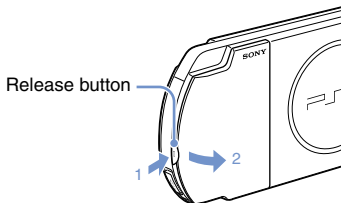
**2 Insert the Battery Pack.**

Align the bottom surface of the battery pack with the system to attach the battery.

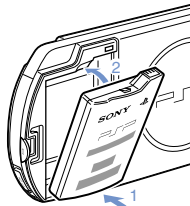

Align the tabs of the battery cover with the system and snap it in place.

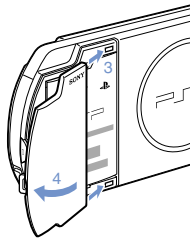

### 3 Attach the AC Adaptor to charge the battery.

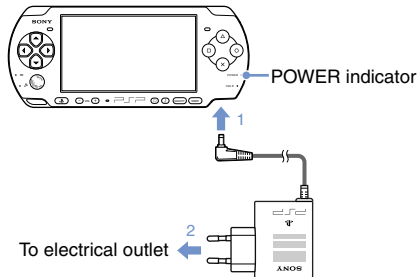

The POWER indicator lights up in orange, indicating that charging has begun. The POWER indicator will turn off when the battery is fully charged.

#### Initial setup

### 1 Slide the POWER/HOLD switch up.

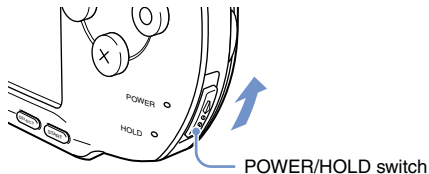

The POWER indicator lights up in green, and the initial setup screen is displayed.

### 2 Follow the on-screen instructions to make the initial settings.

When you have completed initial setup, the Home Menu (▶▶ page 2) is displayed.

#### Hints

- See "Using the on-screen keyboard" (▶▶ page 26) for information on entering characters.
- Settings made during initial setup can be changed later in  (Settings). See the user's guide (▶▶ page 25) for details.

# 03 Preparation

## Part names and functions

### System

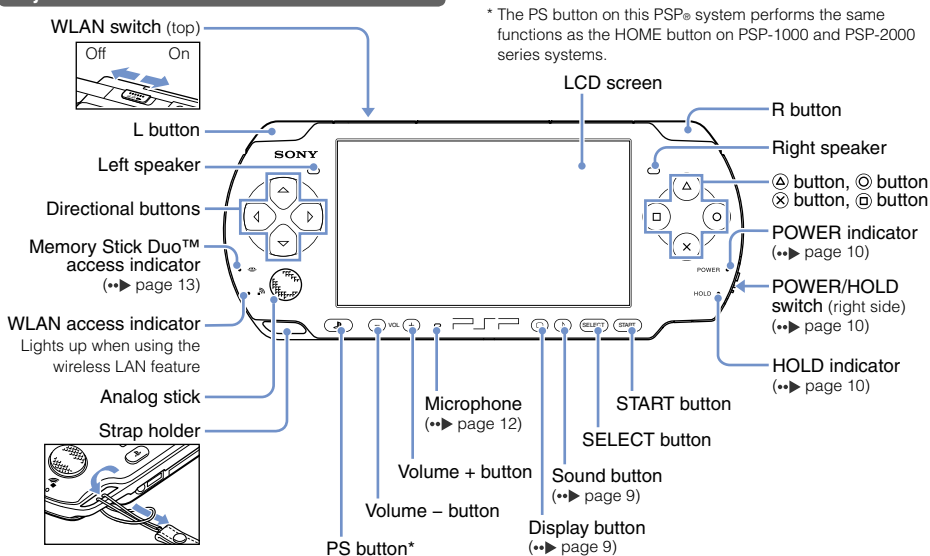





# 04 Basic operations

## Power and sleep mode functions

Use the POWER/HOLD switch to turn the system on or off, or to put it into sleep or hold mode.

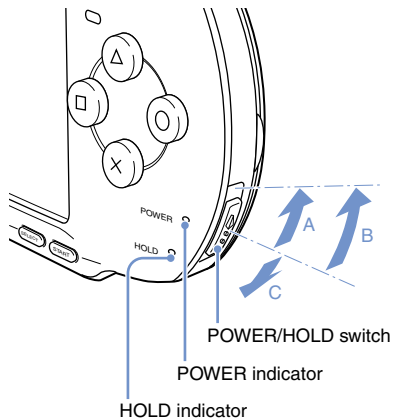





### POWER/HOLD switch

<b>A</b>	<b>Turning the system on / Putting into sleep mode</b>	Slide up
<b>B</b>	<b>Turning the system off</b>	Slide up and hold for more than three seconds
<b>C</b>	<b>Locking the system buttons*</b>	Slide down

\*All operations using system buttons are locked.

### POWER indicator

	<b>Solid green</b>	Power on
	<b>Solid orange</b>	Charging
	<b>Flashing green</b>	Charge level is low
	<b>Light off</b>	Power off/in sleep mode

### HOLD indicator

	<b>Solid yellow</b>	In hold mode
---	---------------------	--------------

#### Sleep mode

If the PSP® system is switched to sleep mode, the software that is playing will be paused. When sleep mode is cleared, you can begin playback from the point where the system entered sleep mode.

#### Hints

- To clear sleep mode, slide the POWER/HOLD switch up again. During video or audio playback, you can press the ►|| button of the Remote Control to clear sleep mode.
- Some software may prevent the system from entering sleep mode.

## Playing UMD content

**1 Place your finger in the indentation on the top of the system to open the disc cover.**

**2 Insert a UMD and close the disc cover.**

Check that the disc cover is tightly closed.  
The icon is displayed in the Home Menu.

Do not touch the recorded surface.

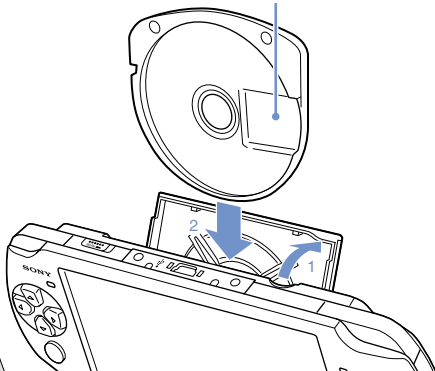

**3 Select the icon, and then press the  $\otimes$  button.**



Playback begins.

### Hints

- Press the PS button to quit a game.
- To remove the UMD, stop playback and then open the disc cover.

### Using the microphone

The PSP® system's microphone (▶▶ page 8) may be used to play certain games and to make calls using Go!Messenger. Refer to instructions for the software in use and visit [gomessenger.bt.com](http://gomessenger.bt.com) for details.

# 06 Basic operations

## Playing Memory Stick Duo™ content

### ⚠ Warning

Keep Memory Stick Duo™ media out of the reach of small children, as the media could be swallowed by accident.

- 1 Open the slot cover.
- 2 Press the Memory Stick Duo™ media until fully inserted.

The icon is displayed in the Home Menu.

Slot cover

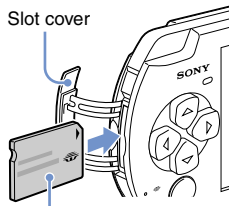

Front side

### Notice

When the Memory Stick Duo™ access indicator (▶▶ page 8) is lit, do not eject the Memory Stick Duo™ media, turn off the system, or put the system into sleep mode. Doing so may cause data loss or corruption.

- 3 Select the icon, and then press the **X** button.



A list of content that can be played is displayed.

### Hint

To remove the Memory Stick Duo™ media, press the media once in the direction of the arrow.

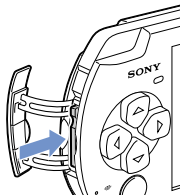

# Checking the battery charge level

Battery charge level



	There is plenty of power left.
	The battery is getting low.
	The battery has almost run out.
	No battery power remains. The POWER indicator flashes green. Recharge the battery.

Depending on the usage conditions and environmental factors, the charge level display may vary from the actual charge level.

## Methods of charging the battery

You can use either of the following methods to charge the battery.

### • Using the AC adaptor

When you connect the AC adaptor to the PSP® system and insert the plug for the power cord into an electrical socket, charging will begin (▶▶ page 6).

### • Using a USB cable (sold separately)

When you turn on the PSP® system and then connect it to a device (such as a PC) equipped with a USB connector, the system will automatically switch to USB mode and the system's battery will begin charging. The power indicator lights up in orange while the battery is charging.

### Hints

- In certain situations, such as during gameplay, the PSP® system will not automatically switch to USB mode when a USB cable is connected to the system.
- To switch to USB mode manually, select (USB Connection) under (Settings).
- You can connect a Mini-B (5-pin) type USB cable to the USB connector of the PSP® system.
- For details about the charging time or duration, refer to the supplied Safety and Support manual.

# 08 Copying music/videos/images

Copy music/video/image files to Memory Stick Duo™ media and play or view files on the PSP® system. Copy methods vary depending on the device and software in use as well as file type. The following instructions are based on the most common copying methods.

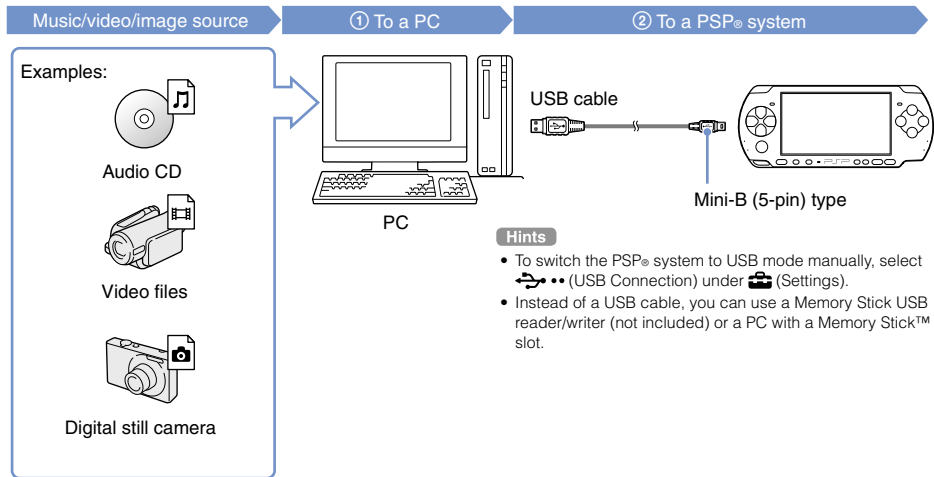

### Copying music/videos/images

#### Copying music files

Example: Importing music tracks from an audio CD

##### 1. Import

Use compatible software to import music tracks from an audio CD to a PC.

##### 2. Copy

Create a folder named "MUSIC" on Memory Stick Duo™ media using a PC, and then save music files in the folder.



#### Hint

You can play MP3, AAC and ATRAC format files.

#### Copying video files

Example: Downloading legally available video files from the Internet

##### 1. Download

Download video files to a PC.

##### 2. Convert/Copy

Use compatible software to convert the video to a file format that can be played on the PSP® system. Then, create a folder named "VIDEO" on the Memory Stick Duo™ media and save the video files in the folder.



#### Hint

You can play some MP4 video files.



### Copying image files

Example: Importing images from a digital still camera

#### 1. Import

Import images to a PC.

Import methods vary depending on the device in use. For details, refer to the instructions supplied with the device.

#### 2. Copy

Create a folder named "PICTURE" on Memory Stick Duo™ media using a PC, and then save image files in the folder.

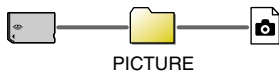

### Conversion software

Media Manager\* for PSP® (PlayStation®Portable) can be used to convert music, video and image files to the required format. When copying files to Memory Stick Duo™ media, the necessary folders are created automatically.

\* Available separately

### Hints

- If using a digital still camera that supports Memory Stick Duo™ media, you can view images by inserting the media from the camera directly into the PSP® system.
- You can view image files in formats such as JPEG (DCF 2.0/ Exif 2.21 compliant), TIFF and GIF.

# 09 Basic operations

## Outputting video to a TV

You can output PSP® system video to a TV using a video output cable (sold separately).





### Selecting a video output cable

Select a video output cable suited for the TV in use.

#### Notice

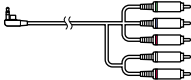
The PSP® system outputs in the NTSC video format. If a display is used which does not support the NTSC video format, no picture will be displayed. Check with the TV manufacturer for details.

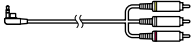
### Video output cable types

Cable type	Input connector on the TV
Component AV cable 	Component VIDEO IN connectors 
AV cable 	VIDEO IN connector (composite) 

#### Hint

Image quality varies depending on the TV in use. Image quality may improve if you connect the PSP® system to your TV using a component AV cable instead of an AV cable.

## Outputting to a TV

### 1 Connect the PSP® system to the TV using a video out cable (sold separately).

Example: Connecting the PSP® system to a TV with component video input connectors

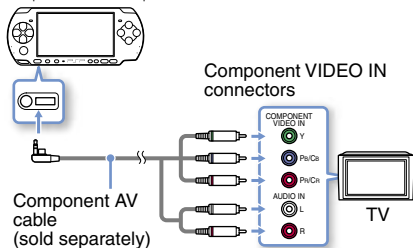

### 2 Adjust the video input setting for the TV.

Set to the input connectors in use.



### 3 Turn on the PSP® system (→ page 10), and then press and hold the display button on the system front for at least 5 seconds.

Video from the PSP® system will be displayed on the TV.

### Clearing video output

To clear video output, press the display button again.

#### Hints

- You can change video output or adjust settings in  (Connected Display Settings) under  (Settings).
- Because the size of the video image output to the TV for games or Internet browser screens is predetermined, horizontal or vertical black bars may be displayed at the edges of the image.

## Adjusting network settings

### **Warning**

Turn off the WLAN switch when in crowded places, such as in a crowded train. If a person nearby is using a pacemaker, it is possible that the radio waves could affect the pacemaker.

### Example of a network configuration

Network equipment connections and setup methods vary depending on the equipment used.

Example of a common network configuration

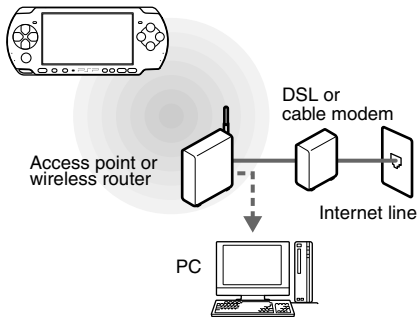

### Required items

The following items are generally required to set up the system to connect to a network.





- Subscription to an Internet service provider
- A network device, such as a DSL or cable modem
- A WLAN access point or a wireless broadband router
- Settings for the access point (SSID, WEP key, WPA key, etc. as specified when the access point was configured)

### Hints

- An access point is a device used to connect to a wireless network.
- A wireless broadband router is a device that includes both router and access point functions. A router is required if you are connecting a PC and the PSP® system to one Internet line at the same time.
- SSID, WEP and WPA keys are types of wireless network information. They may be required when connecting to an access point or a router. This information is generally set in the access point or router using a PC. For details, refer to the instructions supplied with the access point or router.

### Creating a new network connection

You can adjust network settings to connect to an access point and save the network connection data on the system. Network settings may vary depending on the equipment in use and the network environment. The following instructions are based on the most common network configuration and may not apply to all installations.

- 1 Select  (Network Settings) under  (Settings) from the Home Menu, and then press the  button.**
- 2 Select "Infrastructure Mode", and then press the  button.**
- 3 Select "New Connection", and then press the  button.**

- 4 Select "Scan", and then press the right button.**



#### Hint

When using a wireless access point that supports AOSST™, select "Automatic", and then follow the on-screen instructions. The setup will complete automatically. For information on access points that support automatic setup, contact the access point manufacturer.

 **AOSST™**  
A O S S Buffalo, Inc.

### Adjusting network settings

- 5 Select the access point that you want to use, and then press the  $\otimes$  button.**

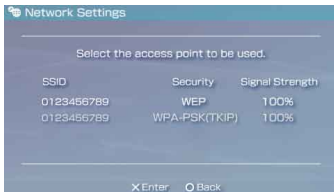

An SSID is a code or a name that is assigned to the access point. If you do not know which SSID to use or if the SSID is not displayed, contact the person who set up or maintains the access point.

- 6 Confirm the SSID for the access point, and then press the right button.**

- 7 Select the security settings as necessary, and then press the right button.**



Security settings vary depending on the access point in use. To determine which settings to use, contact the person who set up or maintains the access point.

- 8 Enter the encryption key, and then press the right button.**

The encryption key field will display an asterisk (\*) for each character you enter. If you do not know the key, contact the person who set up or maintains the access point.

## 9 Select "Easy" or "Custom" and adjust settings as necessary.



<b>Easy</b>	Basic settings are set automatically.
<b>Custom</b>	You can manually enter detailed settings information. For information on settings, refer to the instructions supplied by the Internet service provider or with the network device.

If you select "Custom", follow the on-screen instructions and adjust settings as necessary.





## 10 Check the connection name, and then press the right button.

You can revise the connection name to use any name you like.

## 11 Check the setting list.

The setting values you entered are displayed. Follow the on-screen instructions to complete your network settings.





### Hints

- If the connection test fails, follow the on-screen instructions to check the settings. Network settings for the connection can be changed from the options menu. For additional information, refer to the instructions supplied with the access point or router, or contact your Internet service provider.
- Depending on the access point in use, you may need the MAC address for your system when connecting to a network. You can find the MAC address under  (Settings)   (System Settings)  "System Information".
- For additional information on network settings, refer to the online user's guide (▶▶ page 25).

# 11 Network

## Connecting to the Internet

### Using the Internet browser

- 1 Check that you have access to a wireless network.
- 2 Select  (Internet Browser) under  (Network) from the Home Menu, and then press the  button.
- 3 Using the up button, select the address bar, and then press the  button.

The Internet browser starts.

The on-screen keyboard is displayed.



- 4 Using the on-screen keyboard ([→ page 26](#)), enter the address for the Web page.

After you have entered the address, the PSP® system will connect to the Internet. While the page is loading, the busy icon is displayed in the lower right corner of the screen.

When a connection is successfully established, the Web page will be displayed.



Busy icon



## Basic operations of the Internet browser

Ⓔ button + analog stick	Scroll in any direction
Ⓔ button + directional button	Scroll by screen
L button	Go back to the previous page
△ button	Toggle the menu bar* on and off

\* From the menu bar, you can access various features and settings such as "Back" and "Close Page".

### Hints

- If you try to open a Web page using the Internet browser when a connection to the Internet has not been established, the system will automatically try to connect to the Internet.
- With the default setting, the most recently used connection will be automatically selected when connecting to the Internet.

## Viewing the online user's guide

You can use the Internet browser to view the online user's guide for the PSP® (PlayStation®Portable) system.

- 1 From the Home Menu, select ? (Online Instruction Manuals) under 地球 (Network), and then press the × button.

The user's guide page is displayed.

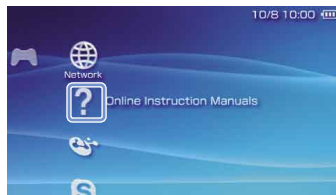

### PSP® system software user's guide

access from : [eu.playstation.com/manuals](http://eu.playstation.com/manuals)

The user's guide can also be viewed using your PC's Web browser.

# 12 Keyboard

## Using the on-screen keyboard

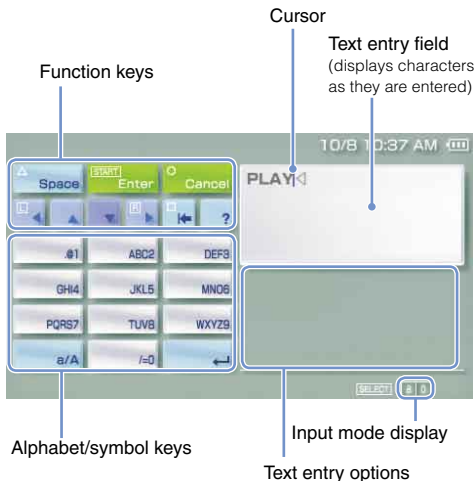

### Control panel item list

Keyboard keys	Function
	Enters a space
	When entering text in the Internet browser address field, previously entered addresses are displayed. Addresses are displayed only when input mode is set to Web address shortcuts.
	Confirms characters that have been typed but not entered, and exits the keyboard
	Cancels characters that have been typed but not entered, and exits the keyboard
	Moves the cursor
	Deletes the character to the left of the cursor
	Displays a diagram showing the system buttons and their usage
	Switches between upper and lower case
	Enters a line break

## Switching input mode

The number of input modes available varies depending on the language selected. Each time you press the SELECT button, the input mode changes among the options in the diagram below:

Input mode display	Input mode	Examples of characters you can enter
	Letters and numbers	a b c d e
	Letters and numbers (with accented letters)	é í ó ç ñ
	Numbers only	1 2 3 4 5
	Web address shortcuts	.com .ne .html .gif

### Hint

The language for the on-screen keyboard is linked to the System Language. You can set the system language by going to (Settings) → (System Settings) → "System Language".

Example: If "System Language" is set to "Français," you can enter text in French.

## Entering characters

This section will demonstrate how to enter text using the word "FUN" as an example.

**1 Select "DEF3", and then press the button several times until "F" is displayed.**

Each time you press the button, the character that is entered in the text entry field is switched.

**2 Select "TUV8", and then press the button several times until "U" is displayed.**

**3 Select "MNO6", and then press the button several times until "N" is displayed.**

**4 Select "Enter", and then press the button.**

The characters you entered will be confirmed. (You can also press the PSP® system's R button to confirm a character.) Select "Enter" again, and then press the button to exit the keyboard.

### Hint

If you select the a/A key while entering characters, you can switch between upper and lower case.

## Updating the system software

Software updates may include security patches, new or revised settings and features, and other items, which will change your current operating system. It is recommended that you always maintain your system to use the latest version of the system software.

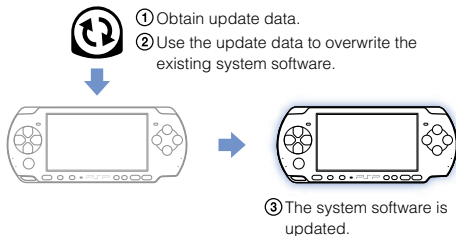

### Notice

During an update:



- Do not remove the UMD.
- Do not turn off the system.
- Do not disconnect the AC Adaptor.

If an update is cancelled before completion, the system software may become damaged, and the system may require servicing or exchange.

### Hints

- For the latest information on updates, visit [eu.playstation.com/psp](http://eu.playstation.com/psp)
- Depending on the software title, you may not be able to play without first updating the PSP® system software.
- After you have updated the system software, you cannot go back to an earlier version.
- Before starting, check that the battery is charged. You may not be able to start an update if the battery charge level is low.

### Checking the system software version

You can check system software version information by selecting  (Settings) →  (System Settings) → "System Information". The current version is displayed in the "System Software" field.



## Update methods

You can perform an update in any of the following ways.

### With an Internet connection

#### Network Update

Update using the PSP® system's wireless LAN feature.

By selecting  (Network Update) under  (Settings), you can connect to the Internet and update your system to the latest system software.

#### Update using a PC

Update using a PC to download update data from the Internet. For detailed instructions, visit [eu.playstation.com/psp](http://eu.playstation.com/psp)

### Without an Internet connection

#### Update using a UMD

You can update using a UMD that contains update data.

- 1 Connect the AC Adaptor to the PSP® system.**
- 2 Insert a UMD that contains update data.**

The update data icon and version number are displayed under  (Game) in the Home Menu.



- 3 Select , and then press the  button.**

The update begins. Follow the on-screen instructions to complete the update.

# 14 Security settings

## Setting the parental control level

The PSP® system includes a parental control feature. You can use this feature to set a password and limit the playback of content restricted by a parental control level (games, videos and other content). By setting the parental control level on the system, you can prevent the playback of restricted content by children.

### About parental control levels

#### Parental control levels on the PSP® system

The parental control level of the system can be either turned off or set to one of 11 different levels.

<b>Off</b>	Turns off parental control
<b>11-1</b>	Sets the level of content to be restricted. A setting of "1" is the most restrictive; "11" is the least restrictive.



The default setting for the menu item is "9".

The combination of the parental control levels of both the PSP® system and the content determine whether the content can be viewed.

Example: If the parental control level of the system is set to "7", content with a level from "1" to "7" can be played on the system.

For further information about Parental Control Levels and corresponding age groups, visit <http://manuals.playstation.net/document/> or refer to PSP® format software manual.

### Setting the parental control level

- 1 Select "Parental Control Level" from  (Security Settings) under  (Settings) in the home menu, and then press the  button.**

The password entry screen is displayed.

- 2 Using the directional buttons, enter the 4-digit password, and then press the  button.**





When entering a password for the first time after purchase, enter "0000".

- 3 Select a level, and then press the  button.**



The parental control level is set.

#### Hint

To change the password, select "Change Password" under  (Settings)   (Security Settings).

"", "PlayStation", "   

"XMB" and "xross media bar" are trademarks of Sony Corporation and Sony Computer Entertainment Inc.

"SONY" and " are registered trademarks of Sony Corporation. Also "Memory Stick", "Memory Stick Duo", "", "MagicGate" and "ATRAC" are trademarks of the same company.

"Go!Messenger" is a trademark of Sony Computer Entertainment Europe.

"**AOSS**" and AOSS™ are the trademarks of BUFFALO INC.



4 - 1 1 5 - 3 6 2 - 4 1

SONY



COMPUTER  
ENTERTAINMENT ®

[eu.playstation.com/psp](http://eu.playstation.com/psp)

Information about system functionality and images published in this document may vary from those for your PSP® system, depending on the system software version in use.

© 2008 Sony Computer Entertainment Inc. All rights reserved.