

SONY®



Welcome to PlayStation®

## Quick Start Guide

English

CUH-2216A / CUH-2216B

7032708

# Let's get started

## 1 Connect to your TV.

Make all connections before plugging the AC power cord into an electricity supply.

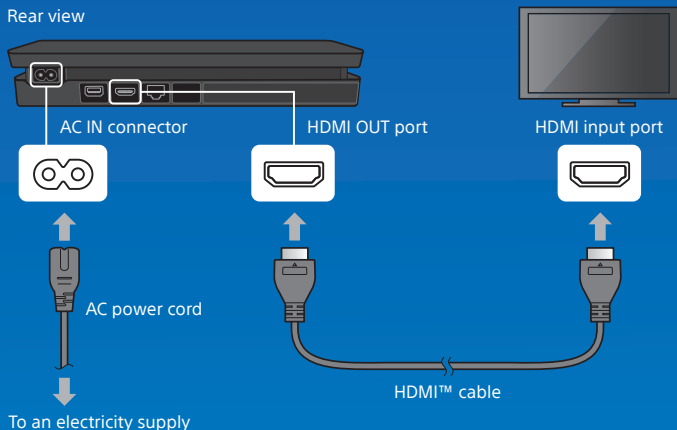

You can transfer saved data from your current PlayStation®4 system to your new PS4™ system. If you intend to do this, we recommend completing the data transfer during the initial set up process for your new system. **If you do it later, any saved data on the new system will be lost.** For guidance on transferring data and the types of data you can transfer, refer to the User's Guide. [manuals.playstation.net/gb/04.html](https://manuals.playstation.net/gb/04.html)



## 2 Connect to the Internet.

We recommend use of a LAN cable (sold separately) for a more stable network connection.

If you prefer to use a wireless connection (Wi-Fi), don't connect a LAN cable.

Rear view

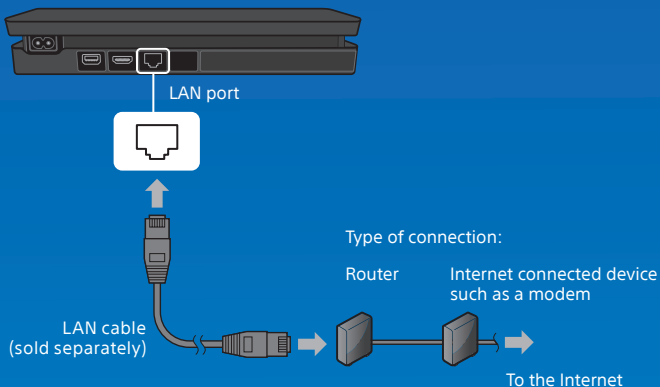

Get the most out of your PS4™ system by connecting to the Internet. You'll be able to play games online and connect with Friends.\*1

**3 Turn on your TV and set the input to HDMI.**

**4 Turn on your PS4™ system by pressing the  (power) button.**

The power indicator blinks blue, and then turns white.

Front view

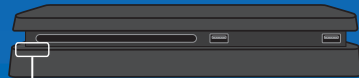

Power button/Power indicator

---

If your TV does not display a picture when the power indicator turns white, restart your system. Press the  (power) button for at least 7 seconds to turn off your system, and then turn it on again.

## 5 Connect your DUALSHOCK®4 wireless controller to your system using the USB cable, and then press the (PS) button.

Your controller pairs with your system and turns on.

Front view

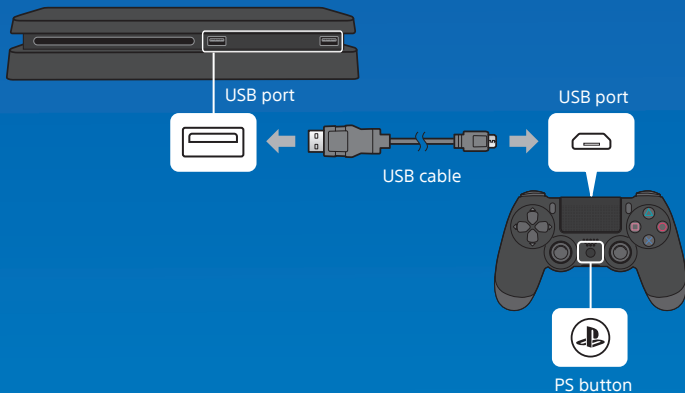

- You'll need to pair a controller when you use it for the first time and when you use your controller on another PS4™ system. If you want to use two or more controllers, you must pair each controller.
- After you've paired your controller, you can disconnect the USB cable and use your controller wirelessly.
- It's possible to use up to four controllers at the same time. When you press the  (PS) button, the light bar glows in your assigned colour. The first controller to connect is blue, with subsequent controllers glowing red, green, and pink.

---

## **6** Make it your own.

You're almost done! Follow the on-screen instructions to set up an Internet connection, set the date and time, and configure other settings - then select [Start Now] from the setup screen.

After you set up your Internet connection, a system software update may automatically download. Future updates will improve performance and add new features.

Will a child be using your PS4™ system? If so, be sure to read the "Parental controls" section.

---

To later change any settings that you skipped, select  (Settings) from the function screen.

# Parental controls

We recommend parents/guardians create a separate account for each child that will use the PS4™ system, with an accurate date of birth for each, to help us provide an age-appropriate experience. Parents and guardians can also use a range of parental controls to tailor the child's experience, including preventing or limiting expenditure on PlayStation™ Store and controlling their opportunities to message and chat, to exchange user-created content – such as images and videos – and to use the in-built Internet Browser.

For further details on what can be restricted and how to set restrictions, refer to the User's Guide.

[manuals.playstation.net/gb/01.html](http://manuals.playstation.net/gb/01.html)



You can restrict the use of games that have age limitations by setting the parental control level according to the following table.

## Europe, Africa and India

Player's Age	Under 3	3-6	7-11	12-15	16-17	18 and over
PS4™ Parental Control Setting	1	2	3	5	7	9
Highest game age rating						

## Germany

Player's Age	Under 6	6-11	12-15	16-17	18 and over
PS4™ Parental Control Setting	1	3	5	7	9
Highest game age rating					



# Take a look around



## Function screen

Access PS4™ system features, including notifications, your Friends, and settings.



Up button



Down button

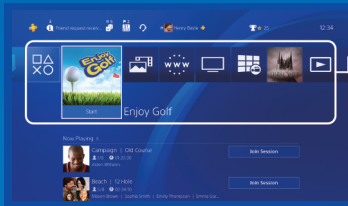

## Home screen

### Content area

Access your games and other content.



Up button



Down button



## Content info screen

The latest information about the selected content is displayed.

# Let's play

## Start the game

Insert a disc. Select the game from the content area to start playing. No game disc? Check out PlayStation™ Store for downloadable games. See "Sign in to PlayStation™ Network".

Front view



## Return to the home screen from a game

To return to the home screen without ending a game, press the  (PS) button.

To resume playing the game, select it from the content area.

## End the game

Press and hold the  (PS) button, and then select [Close Application] from the quick menu that appears.

## Eject the disc

Press the  (eject) button.

Front view

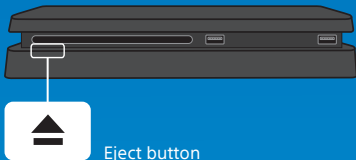

## Connect the mono headset

For in-game voice chat, plug the mono headset into your controller's stereo headset jack.

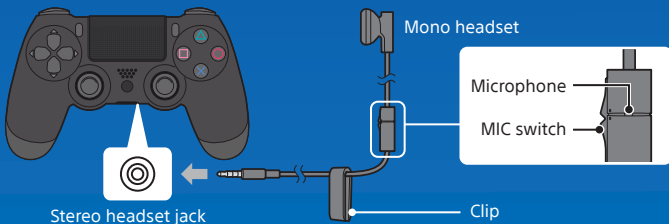

## Charge your controller

With your PS4™ system either on or in rest mode, connect your controller using a USB cable. For details on rest mode, read the "Shutting down" section.

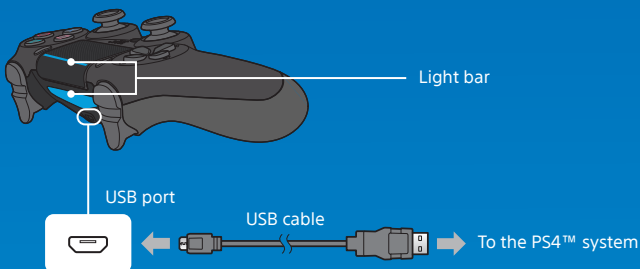

To charge your controller while your system is in rest mode, select an option other than [Off] in  (Settings) > [Power Saving Settings] > [Set Features Available in Rest Mode] > [Supply Power to USB Ports].

# Sign in to PlayStation™Network

PlayStation™Network is an online service that lets you expand your enjoyment of your PS4™ system. Sign in to download games from PlayStation™Store, share your gameplay, and use a variety of other features and services.



Download games



Chat



Connect with Friends



Share your gameplay

To sign in to PlayStation™Network, you must have an account for PlayStation™Network. For details on signing in, refer to the User's Guide. [manuals.playstation.net/gb/03.html](http://manuals.playstation.net/gb/03.html)



PlayStation™Network, PlayStation™Store and PlayStation®Plus subject to terms of use and country and language restrictions. Users are responsible for Internet service fees. Charges apply for some content and / or services. Users must be 7 years or older and users under 18 require parental consent. Additional age restrictions may apply. Service availability is not guaranteed. Online features of specific games may be withdrawn on reasonable notice - [playstation.com/gameservers](http://playstation.com/gameservers). Full terms apply: PSN Terms of Service at [playstation.com/legal](http://playstation.com/legal).

# Share your gaming experience

## Share your gameplay online

Press the SHARE button and choose one of these options for sharing your gameplay online.



### Upload a screenshot

Capture a screenshot of your gameplay and upload it to your social networks, or use  (Messages) to send it to Friends.



### Upload a video clip

Your PS4™ system continuously records the last 15 minutes of gameplay. You can upload a video clip of the recorded gameplay to your social networks.



### Broadcast your gameplay live

Broadcast your gameplay to a live streaming service so others can watch your adventures.

## View shared gameplay

Use  (Live from PlayStation) to view broadcasts, video clips, or screenshots shared by other players.



## Play a game together

Use  (Share Play) to share the game screen with another player and play the same game together.<sup>1,2</sup>



For details on the share feature, refer to the User's Guide.  
[manuals.playstation.net/gb/02.html](https://manuals.playstation.net/gb/02.html)



# Shutting down

## **Caution**

Disconnect the AC power cord from the electricity supply only when the power indicator is off. If you disconnect it while the power indicator is lit or blinking, data might be lost or become corrupted, and you might damage your system. Be sure to read the "Turn off your system completely" section below.

## Put your system in rest mode

When your system is in rest mode, it keeps operating, but at a lower power consumption. You can configure your system to download files and charge a controller while it's in rest mode.

Select  (Power) from the function screen, and then select [Power Options] > [Enter Rest Mode]. The power indicator blinks white, and then turns orange.

To exit rest mode, press the  (PS) button.

## Turn off your system completely

Select  (Power) from the function screen, and then select [Turn Off PS4]. The power indicator blinks white, and then turns off.

## Power indicator



White	System is on.
Orange	System is in rest mode.
Off	System is off.

# Further information

---

## User's Guide

Find out about everything your PS4™ system can do. Learn how to configure settings and how to use each function.

Select  (Settings) >  (User's Guide/Helpful Info) >  (User's Guide) from the function screen.

You can also view the User's Guide by visiting:  
[manuals.playstation.net/document/gb/ps4/](http://manuals.playstation.net/document/gb/ps4/)

You must have an Internet connection to view the User's Guide.



## Safety Guide

Learn how to use your PS4™ system safely. This manual also contains information about specifications. Be sure to read it before using your system.

- <sup>1</sup> PlayStation®4 online multiplayer requires paid-for PlayStation®Plus subscription. PlayStation®Plus subscription only available to holders of an account for PlayStation™Network with access to PlayStation™Store and high-speed Internet. PlayStation®Plus content and services vary by subscriber age.
- <sup>2</sup> Share Play: Unlimited 60 minute sessions. PlayStation®Plus membership, high-speed Internet (2 Mbps upload recommended), PS4™ system and account for PlayStation™Network required. Country, game and other restrictions apply: [playstation.com/shareplay](http://playstation.com/shareplay).

"", "PlayStation", "PS4", "DUALSHOCK" and "PlayStation Shapes Logo" are registered trademarks or trademarks of Sony Interactive Entertainment Inc.

"SONY" and " PlayStation" are registered trademarks or trademarks of Sony Corporation.

The terms HDMI and HDMI High-Definition Multimedia Interface, and the HDMI Logo are trademarks or registered trademarks of HDMI Licensing Administrator, Inc. in the United States and other countries.

Design and specifications are subject to change without notice.

Information about system functionality and images published in this document may vary from those for your system, depending on the system software version in use. Also, the illustrations and screen images used in this guide may vary from the actual product.

The information contained in this guide is subject to change without notice.







Sony  
Interactive  
Entertainment