

**SONY®**



PlayStation®5 Digital Edition

**Safety Guide**

## WARNING

### Electrical shock

To avoid electrical shock, do not open the enclosure. Refer servicing to qualified personnel only.

### Moving fan blades

Keep body parts away from fan blades.



### Seizures induced by light stimulation (Photosensitive Epilepsy)

If you have an epileptic condition or have had seizures, **consult your doctor prior to using this console.**

Some individuals are sensitive to flashing or flickering lights or geometric shapes and patterns, may have an undetected epileptic condition and may experience epileptic seizures when playing videogames or watching video content.

**DISCONTINUE USE IMMEDIATELY** and consult your doctor if you experience any of the following health problems or symptoms when exposed to flashing or flickering lights or other light stimulation whilst playing video games or watching video content: eye soreness, altered vision, migraine, muscle twitching, convulsion or other involuntary movements, blackout, loss of awareness, confusion, or disorientation.

**In addition to the above, DISCONTINUE USE IMMEDIATELY when you experience any of the following symptoms:** headache, dizziness, nausea, fatigue, similar symptoms to motion sickness, or discomfort or pain in any body part such as eyes, ears, hands, arms or feet whilst playing. If the condition persists, **seek medical attention.**

### Radio waves

Radio waves may affect electronic equipment or medical devices (for example, pacemakers), which may cause malfunctions and possible injuries.

- If you use a pacemaker or other medical device, consult your doctor or the manufacturer of your medical device before using the wireless networking feature (Bluetooth® and wireless LAN).
- Do not use the wireless networking feature in the following locations:
  - Areas where wireless network use is prohibited, such as in hospitals. Abide by medical institution regulations when using the console on their premises.
  - Areas near fire alarms, automatic doors and other types of automated equipment.

### Magnets

These products have magnets which may interfere with pacemakers, defibrillators and programmable shunt valves or other medical devices. Do not place these products close to such medical devices or persons who use such medical devices. Consult your doctor before using these products if you use such medical devices.

### Use of Headsets or Headphones

Permanent hearing loss may occur if headsets or headphones (not included) are used at high volume. Set the volume to a safe level. Over time, increasingly loud audio may start to sound normal but can actually be damaging to your hearing. If you experience ringing or any discomfort in your ears or muffled speech, stop listening and have your hearing checked. The louder the volume, the sooner your hearing could be affected.

### Lithium batteries



**WARNING:** This console contains a lithium button / coin cell battery.

- The battery is hazardous. New or used batteries should be kept out of reach of children.
- If swallowed or placed inside any part of the body the lithium button cell battery can cause severe or fatal injuries in 2 hours or less.
- If you think the battery may have been swallowed or placed inside any part of the body, you must seek immediate medical attention.

Do not handle damaged or leaking lithium-ion batteries. If the internal battery fluid leaks, stop using the product immediately and contact technical support for assistance. If the fluid gets on to your clothes, skin or into your eyes, immediately rinse the affected area with clean water and consult your physician. The battery fluid can cause blindness.

## Compliance



This equipment has been tested and found to comply with the limits set out in the EU RE Directive and UK RE Regulation. Only use cables that are either a) supplied with the equipment, b) official PlayStation accessories or c) less than 3 metres in length.

This product has been manufactured by or on behalf of Sony Interactive Entertainment Inc., 1-7-1 Konan Minato-ku Tokyo, 108-0075 Japan.

Imported into the United Kingdom and distributed by Sony Interactive Entertainment Europe Limited, 10 Great Marlborough Street, London, W1F 7LP, United Kingdom.

Inquiries related to product compliance in the UK should be sent to the manufacturer's authorised representative, Sony Europe B.V., The Heights, Brooklands, Weybridge, Surrey KT13 0XW, United Kingdom.

Imported into Europe and distributed by (except the UK) Sony Interactive Entertainment Ireland Limited, 2nd Floor, 2/3 Rogers Lane, Dublin 2, Ireland.

Inquiries related to product compliance in the EU should be sent to the manufacturer's authorised representative, Sony Belgium, bijkantoor van Sony Europe B.V., Da Vincilaan 7-D1, 1930 Zaventem, Belgium.

### FOR CUSTOMERS IN THE UNITED KINGDOM

A moulded plug complying with BS1363 is fitted to this equipment for your safety and convenience. Should the fuse in the plug supplied need to be replaced, a 5AMP fuse approved by ASTA or BSI to BS1362, (i.e., marked with ⚡ or ⚡ mark) must be used. If the plug supplied with this equipment has a detachable fuse cover, be sure to attach the fuse cover after you change the fuse. Never use the plug without the fuse cover. If you should lose the fuse cover, please contact your nearest Sony service station.

### RE Directive "Informal DoC" statement

Hereby, Sony Interactive Entertainment Inc., declares that this product is in compliance with the essential requirements and other relevant provisions of Directive 2014/53/EU. For details, please access the following URL: <https://compliance.sony.eu>

### UK RE Regulation "Informal DoC" statement

Hereby, Sony Interactive Entertainment Inc., declares that this product is in compliance with the relevant statutory requirements. For details, please access the following URL: <https://compliance.sony.co.uk>

This radio equipment is intended to be used with the approved version(s) of software that are indicated in the EU/UK Declaration of Conformity. The software loaded on this radio equipment is verified to comply with the essential requirements of the Directive

2014/53/EU and Regulation S.I. 2017 No.1206. The software version can be found via: Select **Settings** > **System** > **System Software** > **Console Information**.

Wireless frequency band and maximum output power:

- Bluetooth® 2.4 GHz: less than 10 mW
- WLAN 2.4 GHz: less than 100 mW
- WLAN 5 GHz: W52/W53/W56: less than 100 mW, W58: less than 25 mW

This radio equipment was evaluated as receiver category 1 defined in EN 300 440 V2.1.1.

### Product Ecodesign

For resource and energy efficiency information related to the EU Ecodesign requirements of the Regulation (EU) No 801/2013 and also the European Union Self-Regulatory Initiative to further improve the energy efficiency of Games Consoles (recognised under COM(2015) 178 final report of the European Commission), visit the following URL: [playstation.com/Ecodesign](http://playstation.com/Ecodesign)

For resource and energy efficiency information related to The Ecodesign for Energy-Related Products and Energy Information (amendment) (EU Exit) Regulations 2019 and also the UK Games Console Voluntary Agreement, visit the following URL: [playstation.com/Ecodesign](http://playstation.com/Ecodesign)

### Product disposal



Where you see either symbol on any of our electrical products, batteries or packaging, it indicates that the relevant electrical product or battery should not be disposed of as general household waste in the EU, UK, Turkey, or other countries with separate waste collection systems available. To ensure correct waste treatment, please dispose of them via an authorised collection facility, in accordance with any applicable laws or requirements. Waste electrical products and batteries may also be disposed of free of charge via retailers when buying a new product of the same type. Furthermore, within the UK and EU countries larger retailers may accept small waste electronic products free of charge. Please ask your local retailer if this service is available for the products you wish to dispose of. In so doing, you will help to conserve natural resources and improve standards of environmental protection in treatment and disposal of electrical waste.

This symbol may be used on batteries in combination with additional chemical symbols. The chemical symbol for lead (Pb) will appear if the battery contains more than 0.004% lead.

This product contains a battery which is permanently built-in for safety, performance or data integrity reasons. The battery should not need to be replaced during the lifetime of the product and should only be removed by skilled service personnel. To ensure the correct waste treatment of the battery, please dispose of this product as electrical waste.

## System software

Use of this PlayStation®5 console means acceptance of Sony Interactive Entertainment Inc.'s system software licence agreement. Refer to [doc.dl.playstation.net/doc/ps5-eula/](http://doc.dl.playstation.net/doc/ps5-eula/) for further details.

If you cannot update over the internet, you can also use a USB drive.  
For details, visit [playstation.com/system-software](http://playstation.com/system-software).

By updating the system software of the PS5™ console, you can enjoy additional features, improved usability, and enhanced security. Always update to the latest version.

To learn how to update from your PS5 console, go to the home screen, select **Settings**  > **User's Guide, Health and Safety, and Other Information** > **User's Guide**.

## Contents

<b>WARNING</b> .....	2
<b>Compliance</b> .....	3
<b>System software</b> .....	4
<b>Precautions</b> .....	6
<b>Remove and attach covers</b> .....	9
<b>Install an M.2 SSD</b> .....	10
<b>Specifications</b> .....	13
<b>Copyright and trademarks</b> .....	14

## Precautions

Before using this product, carefully read this manual and retain it for future reference. Parents and guardians of children should read this manual and make sure that children follow all safety precautions.

### Safety

This product has been designed with the highest concern for safety. However, any electrical device, if used improperly, has the potential for causing fire, electrical shock or personal injury. To help ensure accident-free operation, follow these guidelines. Observe all warnings, precautions, and instructions. If you are unsure about any information in this manual, contact the appropriate PlayStation® customer service helpline which can be found within the Guarantee booklet.

#### Use of the AC power cord

- Regularly inspect the AC power cord for damage and dust build-up around the power plug or electricity supply.
- Stop use, unplug the AC power cord from the electricity supply and disconnect any other cables immediately if the device functions in an abnormal manner, produces unusual sounds or smells or becomes too hot to touch.

#### Use of the vibration of the wireless controller

- If the wireless controller is sitting on a flat surface, the vibration of the wireless controller during gameplay may cause it to fall, leading to injury or malfunction.
- Do not use the vibration or trigger effect function if you have any ailment or injury to the bones, joints or muscles of your hands or arms. If you have an ailment or an injury, do not play titles with these features using the controller unless you have set those functions to "Off". To enable or disable the features, select **Settings**  > **Accessories** from the home screen.

#### Use of the cover

- Do not use the console without the cover. Doing so may cause fire, electrical shock, or malfunction.

#### Young children injuries

- Keep this product out of the reach of young children. Young children may swallow small parts or may wrap the cables around themselves, which may inflict injury or cause an accident or a malfunction.

#### Volume level

- To protect your hearing, limit the amount of time you use the headset or headphones at high volume.
- Avoid raising the volume to block out noisy surroundings.
- Lower the volume if you can't hear people speaking near you.

## Console use and handling

### Console location

- The console should be installed and operated with a minimum distance of 20 cm away from your body.
- Do not use the console in a closed cabinet or other locations where heat may build up. Doing so may cause the console to overheat and may lead to fire, injury or malfunction.
- If the console becomes too hot, you will see a notification message on your screen. Continued use while the message displays may lead to the console becoming non-operational. If you see the message, turn off the console and wait until it cools down. After the console cools down, move it to a well-ventilated location that is not subject to high temperatures. Check to make sure the console vents are not blocked, and if you installed an M.2 SSD to the console, be sure that the heat-dissipation parts haven't detached from the M.2 SSD. See "Install an M.2 SSD" (➡ page 10) for more information on heat-dissipation parts.
- Do not expose the console, accessories or battery to high temperatures, high humidity or direct sunlight during operation, transportation and storage.

### Well-lit area

- Use in a well-lit area and keep a safe distance from the TV screen.

### Breaks

- Avoid prolonged use of the console. Take a 15-minute break during each hour of play.
- Avoid playing when you are tired or need sleep.
- Stop using the console immediately if you begin to feel tired or if you experience discomfort or pain in your hands or arms while operating the wireless controller. If the condition persists, consult a doctor.
- If you experience any of the following health problems, discontinue use of the console immediately. If symptoms persist, consult a doctor.
  - Dizziness, nausea, fatigue or symptoms similar to motion sickness
  - Discomfort or pain in a part of the body, such as eyes, ears, hands or arms

### Liquid, dust, smoke and steam

- Do not touch product during an electrical storm.
- Do not use the product near water.
- Do not allow liquid, small particles or other foreign objects to get into the product.
- Do not expose product to dust, smoke or steam. Also, do not place the console in an area subject to excessive dust or cigarette smoke. Dust build-up or cigarette smoke residue on the internal components may cause the console to malfunction.

### Use of the base

- Use the included base to set up the console as directed. If you do not use the base and set up the console in ways other than directed, there is a risk of injury, damage, or malfunction. For instructions on attaching the base, see the Quick Start Guide.

- Where you set up the console in a vertical position, you'll need to secure the base to the console with the screw. After using the console, the screw may get hot. Be careful when removing the base or carrying the console immediately after use.

### Use of the cover

- Do not use the console without the cover. Doing so may cause fire, electrical shock, or malfunction. Do not remove the cover of the console immediately after use. The main unit of your PS5 console may still be hot immediately after use, and continued handling with the cover off may cause burns. If you need to remove the cover, turn off your PS5 console, unplug the AC power cord and cables, and wait for it to cool down.

### Placing and handling

- Be careful when carrying the console. If you do not have a good grip, the console may drop causing potential damage or injury. Do not carry the console by the cover only. When attaching the base to the console, hold the console securely and not by the cover only.
- Do not move the console or adjust its position when the power indicator is lit or blinking. Data may be lost or corrupted, or the console may be damaged.
- Do not stand on or put objects on the console, and do not stack the console with other devices.
- Do not place the console and connected accessories on the floor or in a place where they may cause someone to trip or stumble.
- Do not touch the connectors of the console or accessories.

### Power off

- Do not turn off the console while data is being saved on or loaded from the SSD or USB drives.
- Do not remove the AC power cord from the electricity supply until the power indicator has turned off. If you disconnect the AC power cord while the power indicator is lit or blinking, data may be lost or corrupted, or the console may be damaged.

### Low-temperature burns

- Do not allow bodily contact with the console or air from the console vents for an extended period of time while in use. Extended contact under these conditions may cause low-temperature burns.

### Static shock

- When using headsets or headphones in particularly dry air conditions, you may sometimes experience a small and quick (static) shock on your ears. This is a result of static electricity accumulated in the body, and is not a malfunction of your headset or headphones.

### Safe use for children

- Parents are encouraged to monitor children in online activities to ensure safe and responsible internet usage. Refer to [playstation.com/safety](https://www.playstation.com/safety) for further details.

## Vents

---

Do not block any vents. To maintain good ventilation, follow the guidelines below:

- Place the console at least 10 cm away from a wall surface.
- Do not place on a carpet or rug with long fibres.
- Do not place in a narrow or cramped space.
- Do not cover with cloth.
- Do not allow dust to build up on the vents. Use a cleaning tool such as a handheld vacuum cleaner to remove dust buildup.  
It is also recommended to remove the covers, and then use a handheld vacuum cleaner to remove the dust trapped underneath. For details on covers, see "Remove and attach covers" (↔▶ page 9).

## Storage conditions

---

Placing the console, AC power cord, battery or accessories during operation, transportation and storage in the following locations may cause fire, electrical shock, injury, damage, or malfunction.

- An area exposed to smoke, steam or excessive dust.
- An area subject to high humidity direct sunlight or any other area subject to high temperatures, such as near heating equipment or an area where heat may build up.
- A surface that is unstable, tilted or subject to vibration.

## Wireless controller use

---

### Built-in battery

- **Caution** – using the built-in battery:
  - The wireless controller contains a Lithium-Ion rechargeable battery.
  - Before using the wireless controller, read all instructions for handling and charging the battery and follow them carefully.
  - Take extra care when handling the battery. Misuse can cause fire and burns.
  - Never attempt to open, crush, heat or set fire to the battery.
  - Do not leave the battery charging for a prolonged period of time when the wireless controller is not in use.
  - Always dispose of used batteries in accordance with local laws or requirements.

### Motion sensor

- When using the motion sensor function of the wireless controller, be cautious of the following points. If the controller hits a person or object, it may cause accidental injury or damage.
  - Before using the motion sensor function, make sure you have enough space to move around.
  - Firmly grip the wireless controller to prevent it from slipping out of your grasp and causing damage or injury.

- If using a wireless controller that is connected to the PS5 console with a USB cable, make sure there is enough space for the cable so that the cable will not hit a person or object.

### Compatibility

- Controllers intended for use with PlayStation®, PlayStation®2, and PlayStation®3 consoles, such as the analogue controllers (DUALSHOCK® and DUALSHOCK®2) and the DUALSHOCK®3 wireless controller, are not compatible with the PS5 console. The DUALSHOCK®4 wireless controller is compatible with PlayStation®4 format software on the PS5 console, but not with PS5 format software on the PS5 console.

### Light bar

- Do not stare at the light bar on the controller when it is blinking. If you experience discomfort or pain anywhere in or on your body from light stimulation, discontinue use immediately.

### Charging

- Charge in an environment where the temperature range is between 10 °C and 30 °C. Charging may not be as effective when performed in other environments.
- When the wireless controller is not used for an extended period of time, it is recommended that you fully charge it at least once a year in order to maintain battery functionality.

### Limited lifespan

- The battery has a limited lifespan. Battery duration will gradually decrease with repeated usage and age. Battery life also varies depending on the storage method, usage state, environment and other factors.

### AC power cord use

---

- To help ensure safe operation, regularly inspect the AC power cord. If damaged, stop use immediately and contact the appropriate PlayStation® customer service helpline which can be found within the guarantee booklet.
- Do not use a power cord other than the included AC power cord. The AC power cord is designed specifically for use with this console only, and should not be used with other electrical devices.
- Do not touch the plug of the AC power cord with wet hands.
- Protect the AC power cord from being walked on or pinched particularly at plugs, expansion receptacles and the point where the cord exits from the console.
- Do not place heavy items on the cord.
- Do not place the AC power cord near heating equipment and do not expose the cord to heat.
- Do not connect the AC power cord to a voltage transformer or inverter. Connecting the AC power cord to a voltage transformer for overseas travel or an inverter for use in an automobile may cause heat to build up in the console and may cause burns or a malfunction.

- Do not allow dust or foreign matter to build up around the AC IN connector. Before connecting or plugging in the AC power cord, check that there is no dust or foreign matter in or on the power plug or connecting end of the cord, the electricity supply or the AC IN connector on the console rear. If the plug or connector becomes dirty, wipe off with a dry cloth before connecting.
- Unplug the AC power cord from the electricity supply before cleaning or moving the console, or before removing the cover from the console. You should unplug the AC power cord when you do not intend to use the console for an extended period of time.
- When disconnecting, grasp the AC power cord by the plug and pull straight out of the electricity supply. Never pull by the cord and do not pull out at an angle.

### Never disassemble or modify the console or accessories

---

Use the console and accessories according to the instructions in the product documentation. No authorisation for the analysis or modification of the console or accessories, or the analysis and use of its circuit configurations, is provided. Unauthorised modification of the console or accessories will void your warranty. There are no user serviceable components inside the console.

### Network

---

- An internet connection is required to connect to a network.
- You are responsible for internet service fees. For details, refer to the information provided in your service contract or contact your internet service provider.
- Use only an Ethernet cable compatible with 10BASE-T, 100BASE-TX or 1000BASE-T networks. Do not use a cord for a standard residential telephone line or cables of types other than those mentioned here. Using the wrong type of cord or cable can cause more electrical current than necessary to flow through the LAN port, which may lead to heat build-up, fire or malfunction.

### Wireless networking feature

---

- The frequencies used by the wireless networking feature of the console are the 2.4 GHz (WLAN, Bluetooth®)/5 GHz (WLAN) ranges. The 2.4 GHz range of radio waves is shared by various devices. The console has been designed to minimise the effect of other devices using the same range. However, in some cases, interference from other devices may reduce the connection speed, shorten the signal range, or cause the connection to be terminated unexpectedly.
- Operation in the 5150-5350 MHz band is restricted to indoor use only. Installations in road vehicles, trains and aircraft are not permitted for 5250-5350 MHz band.
- When using the console scan function to select a wireless LAN access point, access points that are not intended for public use may be displayed. Only connect to an access point that you are authorised to use, or one that is available through a public wireless LAN or hotspot service.



## Moisture condensation

If the console is brought directly from a cold location to a warm one, moisture may condense inside the console. Should this occur, the console may not operate properly. In this case, turn off and unplug the console until the moisture evaporates (this may take several hours). If the console still does not operate properly, contact the appropriate PlayStation® customer service helpline which can be found within the guarantee booklet.

## Cleaning

For safety reasons, before cleaning the console or connected accessories, disconnect the AC power cord from the electricity supply.

### Exterior surfaces (plastic cover of console and wireless controller)

- Wipe down with a soft, dry cloth.
- To prevent the surface of your console or peripherals from changing colour and quality, follow the guidelines below.
  - Do not spray with or apply insecticides or volatile substances, including paint thinner, benzene, or alcohol. Do not wipe with chemically treated cloths.
  - Do not rest or store your controller or headset on top of your console.

### Ports/connectors

Do not use ports/connectors on the console if they are dirty. They may not conduct electricity properly. When they are dirty, wipe them with a dry cloth.

## Remove and attach covers

Remove the covers when you care for your console or install an M.2 SSD. Place your console on a soft cloth spread over a flat surface before removing or attaching the covers.

### ⚠ Caution

- Keep out of reach of young children. Small parts such as screws may accidentally be swallowed and cause choking.
- After you have turned off your PS5 console and unplugged the AC power cord and cables, wait for your console to cool down before removing and attaching the covers. The main unit of your PS5 console may still be hot immediately after use, and continued handling of your console may cause burns.
- Be careful not to pinch your fingers in the gaps between parts, and not to hurt your hands and fingers on the corner of parts.
- When turning on your console, make sure the covers are installed correctly. If the covers are not installed correctly, it may cause the main unit to overheat.

- 1 Go to the control centre and select **Power**  > **Turn Off PS5**. The screen goes blank, the power indicator flashes white, and then turns off.
- 2 Remove the AC power cord and cables, and then wait for the PS5 console to cool down. The main unit of your console is hot immediately after use.
- 3 Remove the base.
- 4 Remove the covers by slightly pulling up on them in the direction of the arrow.

Top cover

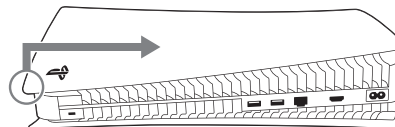

Bottom cover

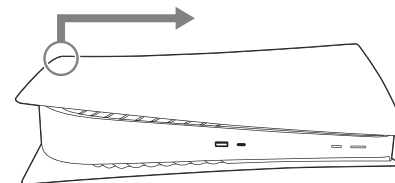

- 5 To attach the covers, firmly push them in the direction of the arrow until you hear a “click”.

Top cover

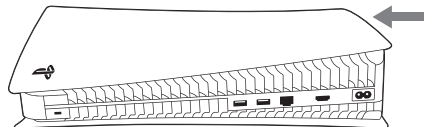

Bottom cover

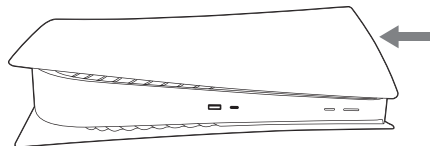

- 6 Attach the base, connect the AC power cord and cables, and then turn on the power

## Install an M.2 SSD

M.2 SSD is storage that uses flash memory. Install a commercially available M.2 SSD in your PS5 console for more storage for your game and app data.

### Types of M.2 SSD

You can use an M.2 SSD with the following specifications:

Interface	PCI-Express Gen4x4 supported M.2 NVMe SSD (Key M)
Storage	250 GB – 4 TB
Supported sizes	2230, 2242, 2260, 2280, 22110
Size including heat-dissipation mechanism	Width: up to 25 mm Length: 30/42/60/80/110 mm Thickness: up to 11.25 mm (up to 8.0 mm from above the board, up to 2.45 mm from below the board)

### Notices

- Both single-sided devices and double-sided devices are supported.
- M.2 SATA SSD is not supported.
- Allocation of host memory to HMB (Host Memory Buffer) supported devices is not supported.
- Carefully review drive specifications prior to purchase and contact the vendor or manufacturer if you need further information. SIE cannot guarantee that all M.2 SSD devices meeting the specifications above will work with your console and assumes no responsibility for the selection, performance or use of third-party products.

### About M.2 SSD heat-dissipation

The M.2 SSD that can be used with this device has a fast transfer speed and is therefore subject to reaching high temperatures. If the M.2 SSD does not include a heat-dissipation mechanism, attach a heat conductor, such as a heat sink, a heat transfer sheet, or both. For information on how to attach the heat conductor, refer to its manual. If you use your device without heat-dissipation parts, or the heat-dissipation parts come off during use, the main unit may overheat, and continued use may cause operation failure.

## Install or remove an M.2 SSD

### Safety warnings

#### ⚠ Caution

When turning on your console, make sure the cover and expansion slot cover are installed correctly. If the cover and expansion slot cover are not installed correctly, it may cause the main unit to overheat.

#### Notices

- Before proceeding with the installing or removing process, touch a metal-grounded object to remove any static electricity from your body. Failure to do so may cause damage to an M.2 SSD or PS5 console. In particular, an M.2 SSD uses parts sensitive to static electricity, so please use caution.
- Do not touch the terminal of an M.2 SSD or your PS5 console's expansion connector.
- When attaching or removing screws, use a screwdriver that matches the sizes of the screws. If the sizes do not match, the screw may become stripped.
- Be careful not to drop small parts such as screws and spacers in the main unit of your PS5 console. If small parts do fall in the main unit, do not turn on the power, and instead consult the support website (➡ back cover).

### Install an M.2 SSD

For safety warnings when installing an M.2 SSD or for details about covers, see "Remove and attach covers" (➡ page 9).

- You can use M.2 SSD storage with system software versions 21.02-04.00.00 and later.
- Place your console on a soft cloth spread over a flat surface before installing the M.2 SSD.

- 1 Remove the bottom cover (➡ page 9).
- 2 Remove the screw from the expansion slot cover and then remove the cover.

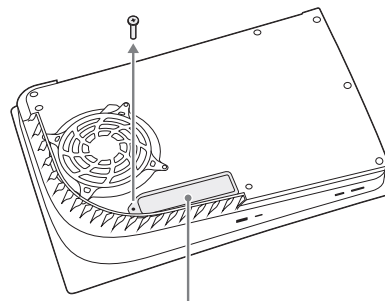

Expansion slot cover

- 3 Install the M.2 SSD to the expansion connector.
  - ① Remove the screw and spacer, and then adjust the spacer to the size of the M.2 SSD.

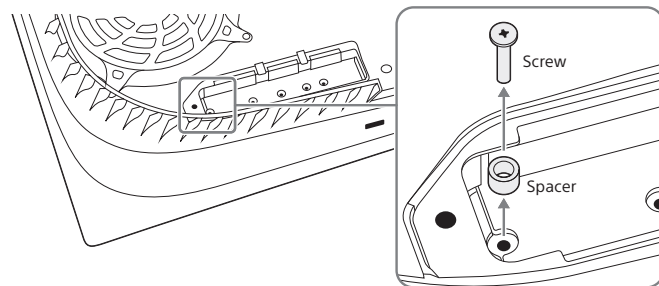

- ② Holding the edge of the M.2 SSD, align it with the notch on the expansion connector. Tilt the M.2 SSD diagonally upward, and firmly insert it all the way into the expansion connector.  
The following shows an M.2 SSD with a heat sink and heat transfer sheet attached.

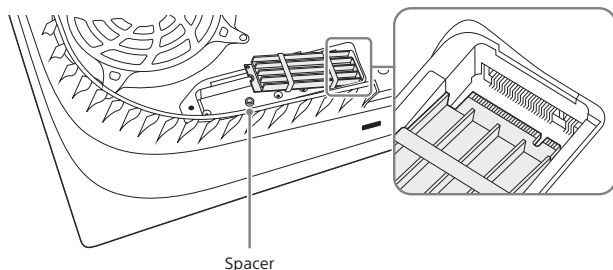

- ③ Tilt the M.2 SSD down and fasten it with the screw.

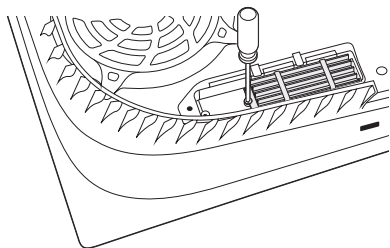

## Remove an M.2 SSD

Place your console on a soft cloth spread over a flat surface. You can then remove the M.2 SSD.

- 1 Remove the bottom cover (➡ page 9).
- 2 Remove the screw from the expansion slot cover, and then remove the cover.
- 3 Remove the fastened M.2 SSD screw.
- 4 Slightly lift up the M.2 SSD, and then hold the edge and pull diagonally upward.
- 5 Fasten the screw back on the spacer.
- 6 Attach the expansion slot cover and fasten the screw.
- 7 Attach the bottom cover (➡ page 9).

- 4 Attach the expansion slot cover and fasten the screw.
- 5 Attach the bottom cover (➡ page 9).
- 6 Attach the base, connect the AC power cord and cables, and then turn on the power.

When your PS5 console turns on, the formatting guide appears. Follow the onscreen instructions and format the M.2 SSD.

### Hints

- Consult our support website if you lose parts such as the expansion slot cover, screws, and spacers (➡ back cover).
- For information about how to save your game data on M.2 SSD storage and the types of data you can save, see the User's Guide (➡ back cover).

## Specifications

Design and specifications are subject to change without notice. Depending on the software version in use, the console may operate differently than described in this manual.

### PlayStation®5 console

Main Processor	Single-chip custom processor CPU: x86-64-AMD Ryzen™ "Zen2", 8 cores/16 threads GPU: 10 TFLOPS, AMD Radeon™ RDNA-based graphics engine
Memory	GDDR6 16 GB
Storage	825 GB Custom SSD*1
Input/output*2	USB Type-A port (Hi-Speed USB) USB Type-A port (SuperSpeed USB 10Gbps) ×2 USB Type-C® port (SuperSpeed USB 10Gbps) Expansion connector (Key M)
Networking	Ethernet (10BASE-T, 100BASE-TX, 1000BASE-T) IEEE 802.11 a/b/g/n/ac/ax Bluetooth® 5.1
AV output	HDMI™ OUT port*3
Electrical rating	220-240 V ~ 1.60 A 50/60 Hz
Maximum rated power	340 W
External dimensions (excluding projecting parts)	Approx. 390 × 92 × 260 mm (width × height × depth)
Mass	Approx. 3.4 kg
Operating temperature	5 °C to 35 °C

\*1 A portion of the SSD capacity is reserved for use in connection with console administration, maintenance and additional options. As a result, the availability of SSD capacity may vary.

\*2 Usability of all connected devices is not guaranteed.

\*3 Use the included HDMI cable.

### Wireless controller

Input power rating	5 V ⎓ 1 500 mA
Battery type	Built-in lithium-ion battery
Battery voltage	3.65 V ...
Battery capacity	1 560 mAh
Operating temperature	5 °C to 35 °C
Mass	Approx. 280 g

## Copyright and trademarks

“”, “PlayStation”, “”, “PS5”, “DUALSHOCK” and “PlayStation Shapes Logo” are registered trademarks or trademarks of Sony Interactive Entertainment Inc.

“SONY” and “” are registered trademarks or trademarks of Sony Group Corporation.

AMD, Radeon and Ryzen are trademarks of Advanced Micro Devices, Inc.

The Bluetooth® word mark and logos are registered trademarks owned by Bluetooth SIG, Inc. and any use of such marks by Sony Interactive Entertainment Inc. is under license. Other trademarks and trade names are those of their respective owners.

The terms HDMI and HDMI High-Definition Multimedia Interface, and the HDMI Logo are trademarks or registered trademarks of HDMI Licensing Administrator, Inc. in the United States and other countries.

USB-IF SuperSpeed USB Trident logo is a registered trademark of USB Implementers Forum, Inc.

USB Type-C® and USB-C® are registered trademarks of USB Implementers Forum.

All other trademarks are the property of their respective owners.

## Quick Start Guide

Learn how to set up your PS5 console and how to use basic functions in the included Quick Start Guide.

## User's Guide

Find out about everything your PS5 console can do. Learn how to configure settings and how to use each function. To see the User's Guide, you'll need an internet connection.

From your PS5 console's home screen, go to **Settings** ⚙️ > **User's Guide, Health and Safety, and Other Information** > **User's Guide**.

## Customer Support Website

Find online support information such as step by step troubleshooting and frequently asked questions by visiting [playstation.com/help](https://playstation.com/help).



The information contained in this manual is subject to change without notice.

The commercial use or rental of this product is prohibited.

